

7 Series

Owner's Handbook



730i

730i

740i

740iL

750i

750iL



BMW AG

In the interests of continuing technical development, we reserve the right to modify designs, equipment and accessories.

Dimensions, weights and performance data quoted in this handbook are to the tolerances laid down by the German Institute for Industrial Standards (DIN). National-market versions may differ from those described here.

Fuel consumption data are according to the values available at the time of closing for press.

Therefore, no claims based on data, illustrations or descriptions in this handbook will be entertained. Errors and omissions excepted.

Please note that this owner's handbook also describes all special equipment features as far as these are relevant to correct operation.

All equipment marked with an asterisk (*) is specification-related and only included as standard on certain models or national-market versions, or is available as a special equipment feature or special accessory.

Any discrepancies between your BMW and the details given here may be due to the equipment specification offered on a particular model or the items ordered with the car.

For a description of special equipment items not included in this handbook, refer to the installation or operating instructions provided.

The BMW Service Organization will be pleased to help in cases of doubt.

In the interests of operational reliability, vehicle safety and a high resale value, refrain from modifying the vehicle's specification in such a way that individual items no longer comply with the general operating permit or the model specification no longer applies.

© 1993 BMW AG
Munich, Federal Republic of Germany

Not to be reproduced wholly or in part without written permission
from BMW AG, Munich

Order No. 01 41 9 787 701 En
Englisch VIII/93
Printed in Germany

Printed on environmentally friendly paper (bleached without chlorine,
recyclable)

Important information for your safety!

For your own safety, use spare parts and accessories approved by BMW.

When you use accessories tested and approved by BMW and Original BMW Parts, you have the assurance that their suitability for your vehicle has been thoroughly tested by BMW. BMW bears full product responsibility for these items.

BMW cannot entertain any liability for spare parts and accessories of any kind which it has not approved.

BMW cannot test whether every product from other manufacturers can be used on a BMW safely and without risk to either the vehicle or the people it is carrying. Moreover, this guarantee cannot normally be provided by an official test or inspection, or by the general operating permit for the part or accessory in question, as tests do not necessarily cover all eventualities.

Original BMW Parts, BMW Accessories and other products approved by BMW, together with experienced advice on using these items, are available from all authorised BMW service stations.

Congratulations on your choice of a BMW.

The better you are acquainted with your car, the easier you will discover driving to be. We therefore request you to heed the following piece of advice:

This owner's handbook contains important information on operating and looking after your BMW. Please read it carefully before setting out in your new car, so that you are fully familiar with the technical advantages of your BMW. It also contains useful information on care and maintenance, to maintain both the car's operating safety and its full resale value.

Wishing you many an enjoyable and safe journey,

BMW AG

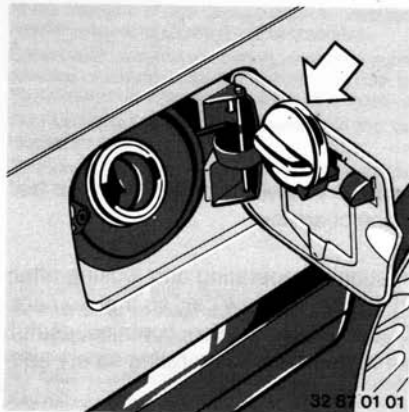

Adding fuel

To open the fuel filler, turn the cap counter-clockwise and take it off.

To close the fuel filler, place the cap on the filler and turn it clockwise until it engages (bayonet-type catch).

Warning: always observe the appropriate safety regulations when handling fuels.

To release the fuel filler if the central locking system fails:

- Remove the rear trim (quick-release catches)
- Lift up the floor mat on the right
- Remove the luggage compartment trim on the right
- Push back the locking bar (reach through from above).

Fuel grades

Catalyst-equipped cars

BMW 730i with 6-cylinder engine, 750i/iL
Unleaded regular fuel for spark-ignition engines to DIN 51607 standard or equivalent, minimum octane number 91 (RM).

BMW 730i with 8-cylinder engine²⁾, 740i/iL²⁾

Unleaded premium fuel for spark-ignition engines to DIN 51607 standard or equivalent, minimum octane number 95 (RM) (Euro Super).

Cars without catalytic converter¹⁾

BMW 730i with 6-cylinder engine, 750i/iL
 All fuels for spark-ignition engines (leaded or unleaded), minimum octane number 91 (RM).

BMW 730i with 8-cylinder engine²⁾, 740i/iL²⁾

Unleaded premium fuel for spark-ignition engines to DIN 51607 standard or equivalent, minimum octane number 95 (RM) (Euro Super) or

Premium fuel for spark-ignition engines to DIN 51600, minimum octane number 98 (RM) or premium fuel, minimum octane number 95 (RM).

Further checks:

	see Page:
- Tyre pressures (including the spare wheel), twice a month	131, 132
- Engine oil level	77
- Battery acid level (add distilled water if necessary)	85
- Coolant level	82
- Brake fluid level	81
- Vehicle lights (renewing bulbs)	94
- Cleaning fluid for the windscreen, headlight and fog light cleaning systems and intensive cleaning system	83

¹⁾ Catalytic converter can be retrofitted

²⁾ These engine versions with knock control can also run on fuel with a minimum octane number of 91 (RM); performance and fuel consumption are affected as a result.

Operating instructions

Practical hints

Care of the car

Technical data

Index



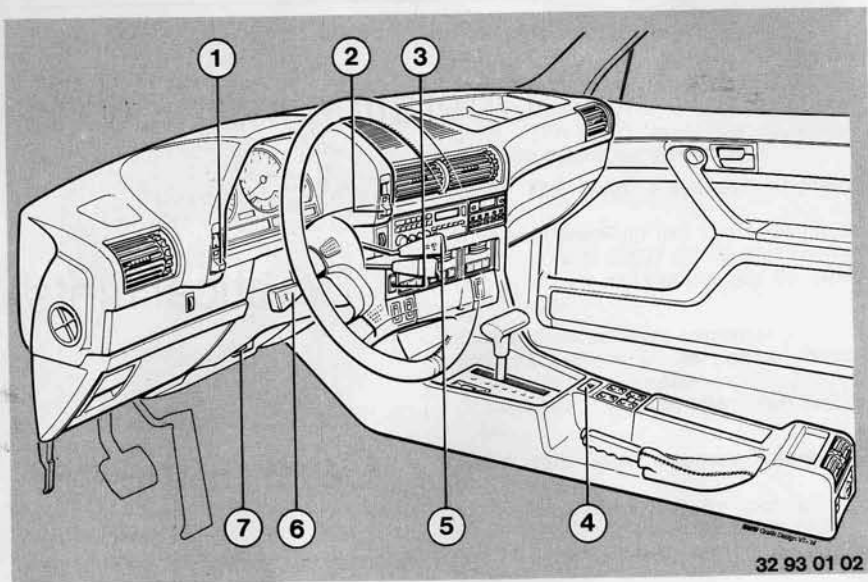

Main controls

	Page
1 – Headlight switch	22
2 – Fog light switch	30
3 – Rear window heater	30
4 – Hazard warning flashers	30
5 – Wipe/wash lever	23
6 – Lever for turn indicators, parking lights, low/high headlight beams and headlight flasher	22
7 – Steering column adjusting lever	14

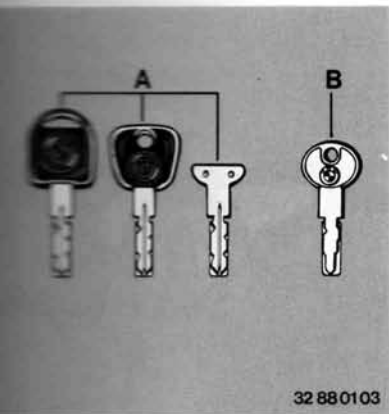

Keys

Master key

Main key with battery and light in key head (press BMW emblem to operate).

Spare key.

Duplicate key for safe keeping, e.g. in wallet or purse.

Door and ignition key

Does not fit the luggage compartment or glove box locks.

In case you need further or replacement keys, a self-adhesive label bearing the key number is provided. Keep this label in a safe place to safeguard against theft of the car.

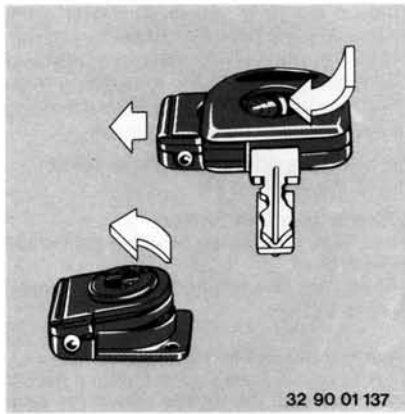

Main key with battery and light

If the light becomes dim, renew the battery in case acid begins to leak out.

Changing the battery: see illustration.



Hand in spent batteries at a collection point for used batteries or at your BMW service station.

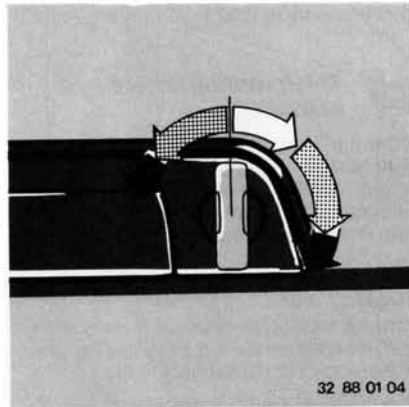

Central locking system – locking

Whenever a door lock or the luggage compartment lock is operated or the safety catch button on the driver's door is pressed down, the doors and the luggage compartment lid and fuel filler flap locks are all engaged at the same time. The locks operated by the central locking system are released automatically in the event of a collision, and the hazard warning flashers and interior lights are switched on.

When the driver's door is open, its safety catch button cannot be pressed down; this is to avoid being locked out of the car accidentally.

Note: if the front passenger's door catch should not be retracted when locked by the normal procedure, the door has been opened via the emergency function and must therefore be locked according to the

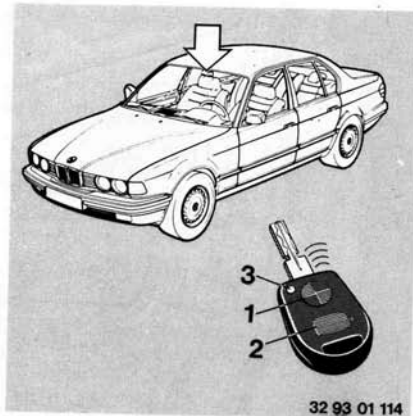

32 93 01 114

Remote control with infrared transmitter

Point the transmitter at the receiver located below the car's interior mirror (max. 5 metres away). The beam must reach the receiver directly.

Opening: press button 1.

- The LED (3) comes on briefly
- The central locking system and thiefproofing device are released
- The alarm system is de-activated
- The car's interior light is switched on.

Closing: press button 1.

- The LED comes on briefly
- The central locking is engaged.

Thiefproofing: press button 2 within 15 seconds of pressing button 1.

- The LED comes on briefly
- The thiefproofing device is engaged
- The alarm system is activated.

To switch off the alarm system's tilt alarm sensor (see also Page 48): press button 2 again after activating the thiefproofing device.

Convenient closing circuit:

To close the windows and sliding/tilt roof, hold buttons 1 or 2 depressed. The closing procedure will start after a delay of app. 2 seconds and the LED flashes.

Note:

If button 1 is released inadvertently, it must be pressed again briefly, released and then held depressed in order to restart the desired procedure.

Warning:

During the closing process, check that there is no danger of fingers etc. being trapped. The closing process is interrupted immediately when the button is released.

Master key

The key on the infrared transmitter is a master key.

All remote-control functions can also be performed with the conventional keys (see Page 7).



32 93 01 115

Batteries

Renew the batteries if the LED does not come on when a button is pressed, and closing movements cannot be performed:

Lever off the cover at the recess (arrow) with the aid of a screwdriver.

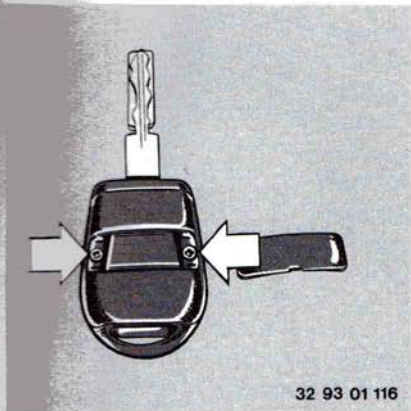

Remove the 2 screws (arrows) and take off the cover.

The correct battery type and installed position are printed on the battery holder.

Important:

Use only batteries of the specified type.



Hand in spent batteries at a collection point for used batteries or at your BMW service station.



Initialising the transmitter

After renewing the transmitter battery, the infrared transmitter must be initialised (unless renewing takes less than one minute and none of the buttons is pressed). The same applies if a new transmitter has been obtained, e.g. to replace a faulty one:

- The car must have been opened using the remote control.
- Close the driver's door.

Important:

If the driver's door is not closed, the initialising process can still be carried out but any further initialising process in future is blocked. This blocking must then be rectified by a BMW service station.

- Briefly turn the ignition key in the steering lock to position 1 (for max. 5 seconds), then back to 0.

- Press button 1 (illustrated) on the transmitter and hold depressed. Press button 2 three times within 10 seconds, meanwhile always keeping button 1 depressed. Release button 1; the LED will flash slowly for max. 10 seconds.
- While the LED is flashing, hold the transmitter close to the receiver under the inside mirror (at a distance of no more than app. 15 cm) and press one of the two buttons.
- The central locking function will be engaged and immediately released again, indicating that the transmitter has been successfully initialised.

If the LEDs do not flash or if the central locking does not respond, the initialising procedure must be repeated.

Any other transmitters used for the car (up to four are possible) must each be initialised within 30 seconds. Do not operate the ignition this time.

If a transmitter develops a fault, a replacement can be obtained from your BMW service station.

Note:

In the same way that any key can be copied, the infrared transmitter's signal can also be reproduced. To guard against abuse, the code is changed automatically each time the transmitter is used and it can be re-initialised at any time. You should nevertheless always protect the infrared transmitter against use by unauthorised persons.

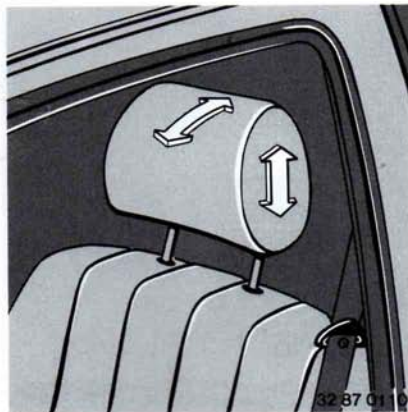
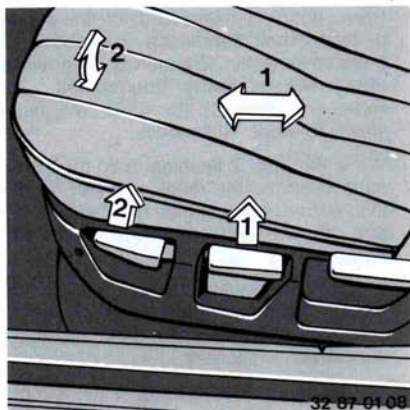

Seats

Moving seat forward/back

Pull lever (1) and push the seat to the desired position.

After releasing the lever, make sure that the seat engages in its catches.

Angle of complete seat

(driver's seat only)

Pull lever (2) and move the seat as required.

Seat back adjustment

Pull lever (1) and apply weight against the seat back or allow it to come forward.

Seat height adjustment

Press lever (2). Apply weight to seat or allow it to come up as required.

Warning:

Do not reposition the driver's seat while the car is in motion. A sudden seat movement could cause you to lose control of the car and result in an accident. Nor should the front passenger's seat be fully reclined while the car is being driven.

Note:

The spine obtains most relief when you sit right back in the seat and rest against the seat back.

Ideally, the driver's head should be on a straight line forming a direct extension of the spinal column.

On longer journeys the seat back angle can be increased slightly to reduce further the strain on the body muscles. However, the driver must still be able to reach the full circumference of the steering wheel with the arms slightly bent.

Front and rear head restraints

To alter the height, pull up or push down as required.

Pivot forward or back to adjust the angle.

Warning:

Head restraints are intended to reduce whiplash injuries in the neck and upper spinal region. The centre of the head restraint should therefore be positioned approximately at ear level.

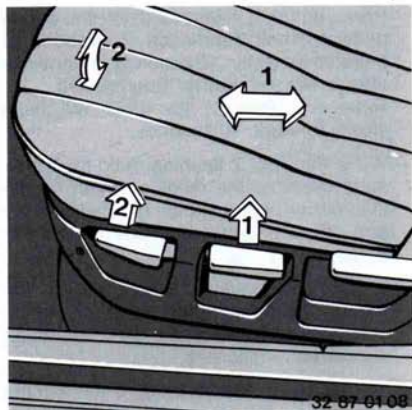

Seats

Moving seat forward/back

Pull lever (1) and push the seat to the desired position. After releasing the lever, make sure that the seat engages in its catches.

Angle of complete seat

(driver's seat only)

Pull lever (2) and move the seat as required.

Seat back adjustment

Pull lever (1) and apply weight against the seat back or allow it to come forward.

Seat height adjustment

Press lever (2). Apply weight to seat or allow it to come up as required.

Warning:

Do not reposition the driver's seat while the car is in motion. A sudden seat movement could cause you to lose control of the car and result in an accident. Nor should the front passenger's seat be fully reclined while the car is being driven.

Note:

The spine obtains most relief when you sit right back in the seat and rest against the seat back.

Ideally, the driver's head should be on a straight line forming a direct extension of the spinal column.

On longer journeys the seat back angle can be increased slightly to reduce further the strain on the body muscles. However, the driver must still be able to reach the full circumference of the steering wheel with the arms slightly bent.

Front and rear head restraints

To alter the height, pull up or push down as required.

Pivot forward or back to adjust the angle.

Warning:

Head restraints are intended to reduce whiplash injuries in the neck and upper spinal region. The centre of the head restraint should therefore be positioned approximately at ear level.



Electric front seat adjustment *

- 1 – Seat angle adjustment
- 2 – Forward/back seat movement
- 3 – Seat height adjustment
- 4 – Seat back angle adjustment
- 5 – Head-restraint height adjustment

BMW sports seat*

Additional adjustment of thigh support at rocker switch on outer edge of seat frame (switch A in illustration).

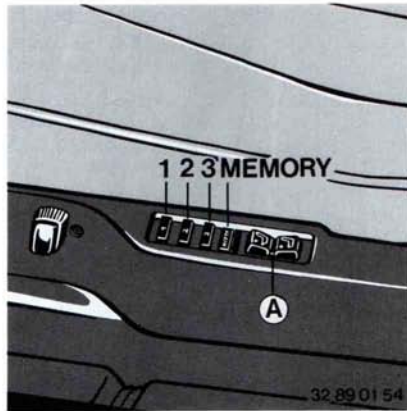

Seat, mirror and steering wheel memory *

Three different seat, mirror and steering wheel positions* can be programmed and selected when required.

Programming (ignition key position 1 or beyond):

- Move seat, mirrors and/or steering wheel to the desired positions.
- Press the MEMORY button; the telltale lamp shows readiness for programming.
- Press button 1, 2 or 3 to store these settings. The telltale lamp then goes out.

Selecting:

With the driver's door open or with the door closed but the automatic interior light still on or the ignition key turned to position 1:

Press the desired button 1, 2 or 3 briefly. The automatic movement process is interrupted as soon as a seat or mirror control switch or the memory keys are operated.

With the driver's door closed and the ignition key either removed or in position 0 or 2:

Press the desired button 1, 2 or 3 until the resetting procedure has been completed.

Tilting down passenger's door mirror

Mirror changeover switch (see Page 18) in driver's door mirror position: when reverse is selected at the manual gearbox or automatic transmission, the passenger's side door mirror glass tilts down slightly to show the road alongside and behind the near side of the car (edge of kerb etc.), as an aid when parking.

You can de-activate the automatic mirror tilting system by resetting the left/right mirror changeover switch to the "passenger's side mirror" position.

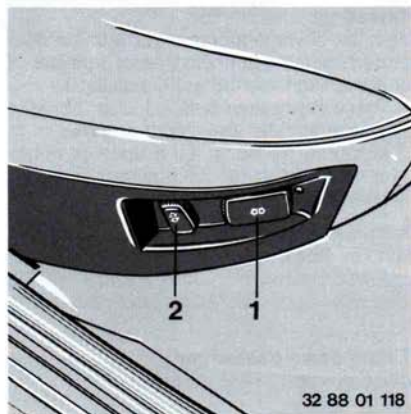

Electric rear seat and rear head restraint adjustment *

- 1 – Forward-back seat movement and seat back angle
- 2 – Head restraint height

When a rear-seat passenger fastens the seat belt, the corresponding head restraint is automatically extended. Its height can be adjusted at switch 2.

Electric rear head restraint adjustment*

The height of the rear head restraint can be adjusted at the rocker switch in the same place.

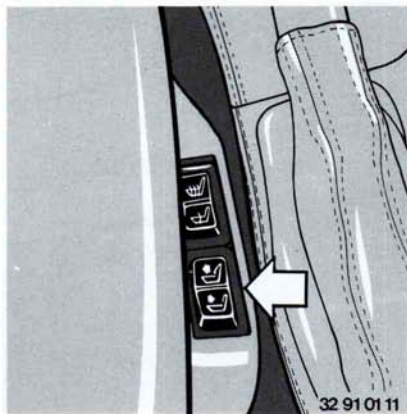

Lumbar support *

Press rocker switch on inner side of seat frame to adjust to the required position.

This facility enables you to extend or retract the convex support in the seat back for the lower spine.

This provides support for the upper pelvis and spine, for a relaxed, upright sitting position.

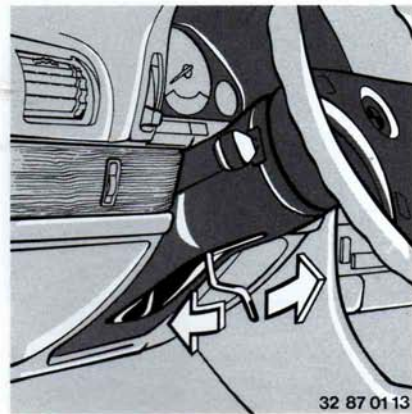

Steering column adjustment

Fold out the clamp lever.

Pull out or push in the steering wheel to adjust its position in relation to the seat. Fold the clamp lever back in.

Warning:

Do not adjust position of the driver's seat or steering column while driving – risk of accident.

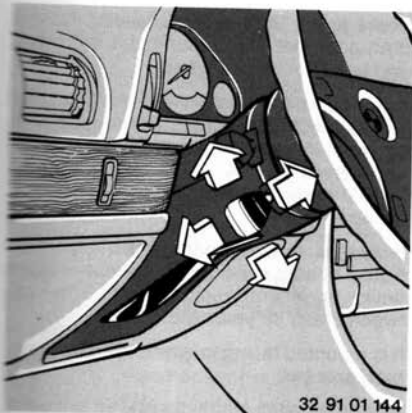

Electric steering wheel adjustment*

The steering wheel can be adjusted for reach (forwards/backwards) and in height* by moving the control lever in the corresponding direction.

Warning:

Never adjust the steering wheel while driving the car – risk of accident.

Memorizing the steering wheel position: see "Seat, mirror and steering wheel memory", Page 13.

Automatic steering wheel position adjustment*

(only with height adjustment)

To make it easier for the driver to enter and leave the car, the steering wheel automatically moves up to its highest position when:

- the ignition key is turned to position 0
- the ignition key is in position 1 and the driver's door is opened
- the ignition key is in position 2, the handbrake is applied and the driver's door is opened.

The steering wheel returns to the driving (memorized) position when:

- the ignition key is in position 2 and the handbrake is released with the driver's door open
- the ignition key is in position 2, the handbrake is applied and the driver's door is closed.



Seat belts

Always wear the seat belts

The lock must be heard to engage when the belt is inserted.

To release the seat belt lock, press the red button on the catch. Guide the belt back on to the automatic reel if necessary.

Place the seat belt across the pelvis and shoulder, making sure that it is not twisted (do not pass the belt over hard or breakable objects in your pockets or clothing). The belt adjusts itself according to body movements.

The belt should be as close to the body as possible, therefore avoid wearing thick and heavy clothing and do not tilt the seat too far back. Take up slack regularly by pulling up the belt at the shoulder.

Warning:

The belt should be as close to the body (and the seat-back angle not too great) for the following reasons:

In the event of a head-on collision, the lap belt could otherwise slide over the hips and injure the lower part of the body. Furthermore, excessive belt slack delays the restraining action.

Pregnant women are also advised to wear the seat belt at all times, making sure that the lap belt is low down over the hips and does not press against the abdomen.

The height of the upper belt anchorage point is automatically adjusted as the seat is moved forward and back, to suit occupants of various heights.

Only one person must be secured by each seat belt.

The seat belt must not pass over the neck, become jammed or be allowed to rub against any sharp edges.

Important:

Never carry babies or small children on your lap when being driven. Use suitable child restraint systems for children up to 12 years old.

Babies up to 9 months old can be carried in a shell-type seat secured to the front passenger's or rear seat by means of the standard seat belts and facing to the rear.

There is the BMW VARIO system for children aged between 9 months and 3 years, and between 3 and 6 years.

For children aged between 9 months and 3 years, the seat is secured at two catches on the front passenger's seat; children aged between 3 and 6 years use the BMW VARIO system and the standard seat belt, facing the front.

A further three-section child's seat consisting of seat shell, seat back and restraint device is generally suitable for children between 2 and 12 years old.

It is mounted facing forward, using the standard seat belt.

Whenever child restraint systems are used, always observe the manufacturer's instructions. The mounting points at the rear are available as standard.

Important:

Child restraint systems mounted on the front passenger's seat are not permitted on cars with a front-passenger airbag.

Do not tamper with any occupant restraint system.

If any damage or severe stress is incurred by a belt system, including the belt-catch tensioner and BMW child restraint systems, the affected components must be renewed by a BMW service station and the belt anchoring points checked.

If the belt-catch tensioner is triggered off, there will be a gap of app. 20 mm between the belt catch and the housing.

The seat belt locking mechanism may operate when:

- the belt is pulled too fast
- the car is braked or accelerated abruptly
- taking corners
- the car is at a steep angle.

Important:

Drivers should also ensure that their passengers also comply with the relevant requirements and instructions concerning the seat belt.

Notes on care: see Page 117.

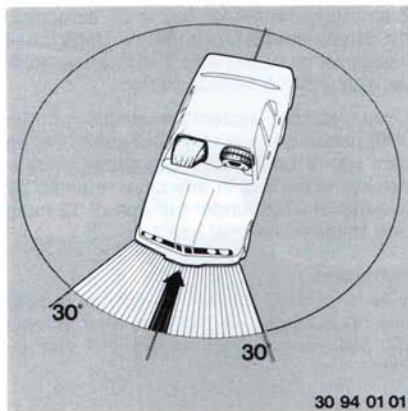

Airbag restraint system

- Driver airbag*
- Front-passenger airbag*

The airbag restraint system protects the driver and front passenger if the car is involved in a severe frontal collision. The inflated airbag restrains forward movement of the driver's and front passenger's body and protects the head and upper body against injury.

The picture shows the area within which the airbag system is triggered off.

In less severe accidents and if the car rolls over, is sideswiped or struck from the rear, protection is provided by the seat belts only.

Warning:

The airbag is an additional safety device and must not be regarded as an alternative to wearing the seat belt.

AIRBAG telltale light on instrument panel

This telltale confirms that the system is in working order when the ignition key is turned to position 1 or beyond.

System operational:

- The telltale light comes on for about 6 seconds, then goes out.

System defective:

- The telltale light does not come on at all.
- The telltale light comes on for about 6 seconds, goes out briefly and then comes on again.
- The telltale light flashes for 5 minutes during a journey, then remains on permanently.

In these cases there is a risk that the system will not be triggered off even if a sufficiently severe accident occurs. Please have it checked by a BMW service station without delay.

What happens when the system is triggered off?

The airbags, which are concealed under flaps in the steering wheel and facia, are inflated rapidly and burst out of the preformed apertures in the padded covers.

The entire process takes place with great force, within a twentieth of a second.

In view of the very brief system response time, the noise of propellant ignition, inflation and subsequent deflation is lost in the general accident situation.

Propellant gas and small quantities of gaseous fumes are released when the airbag is triggered off. They do not represent a health hazard or imply that the car has caught fire.

The sudden increase in pressure inside the car when airbags are inflated may temporarily impair the occupants' hearing.

Warning:

Your seated position should be as far as convenient from the steering wheel or fascia.

Always hold the steering wheel by its rim. Failure to drive in this manner could result in hand or arm injuries if the airbag operates.

No objects should be held or allowed to rest between the airbag and the seat occupant's body.

Even if all the appropriate precautions are taken, the risk of facial injuries when airbags are triggered off cannot be entirely ruled out in all accident situations.

Airbag safety instructions

No modifications to individual components or to the wiring should be attempted. This includes the padded cover in the centre of the steering wheel and the cover on the fascia, which must never be covered with adhesive tape, sheet or any other material or otherwise modified or reworked in any way. The steering wheel itself must not be taken off.

After the airbag has been triggered off, all its components must be renewed.

All work on the airbag system must be carried out by a BMW Service station.

Any unskilled work on or interference with the system could lead to its failure or to accidental triggering off with the risk of injury.

If an airbag generator has to be scrapped, the safety directives issued by BMW must always be complied with. They can be studied at any BMW service station.

Child restraint systems mounted on the front passenger's seat are not permitted on cars with a front-passenger airbag. In certain countries it is in any case required by law that children under the age of 12 must only travel on the rear seats.

Important:

Drivers of cars fitted with airbags should ensure that their passengers also comply with the relevant requirements and instructions.



32 87 01 16

Mirrors

Electric remote-control door mirror

Operate the mirror switch to reposition the mirror as necessary.

Electric mirror heating

The heating element comes on and is controlled automatically when ignition key is in position 2.

Passenger's door mirror

Operate the changeover switch and then the mirror switch to move this mirror to the desired position.

Warning:

This mirror has a convex glass. Objects seen in it are closer than they appear to be, so that it is not always possible to estimate their distance behind the car accurately. This also applies to the outer section of the aspherical wide-angle mirrors.

Aspherical wide-angle mirrors*

The outer section of the mirrors is convex and reflects an enlarged, but slightly distorted, area behind the car. The inner section of the mirror reflects the normal rear-view area.

This improves the driver's range of rearward vision and eradicates the "blind spot" at the rear and side of the car.

Manual mirror operation

Reposition the mirror by moving the glass at the edges.

For mirror memory, see Page 13.

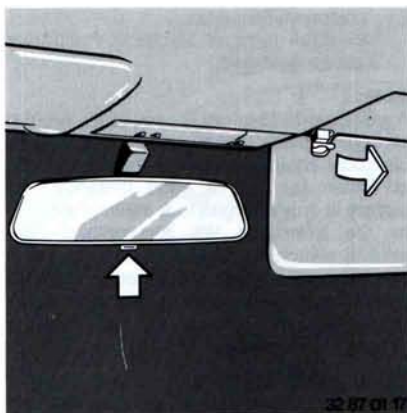
**Inside mirror**

Move the small lever to reduce the effect of glare from following cars' headlights when driving at night.

Inside mirror in conjunction with infrared-transmitter remote control

Turn the knob beneath the mirror.

Position 0: normal position.

Position I: anti-glare position.

Sun visors

These can be pivoted in front of the side windows if necessary.

Make-up mirrors with light

The light comes on when the sun visor is folded down and the car's lights are on. Slide the cover to one side as necessary.

**Automatic-dip inside mirror***

This mirror dips automatically and steplessly in accordance with the intensity of the light received (ambient light and the effect of following headlights).

The mirror automatically switches to the standard, non-dimmed position when reverse gear is engaged.

Automatic-dip inside mirror in conjunction with infrared-transmitter remote control

Turn the knob beneath the mirror.

Position 0: automatic-dip function off.

Position I: automatic-dip function as described above.

Note:

Keep the photo-cells unobstructed and clean in order to preserve the mirror's function.

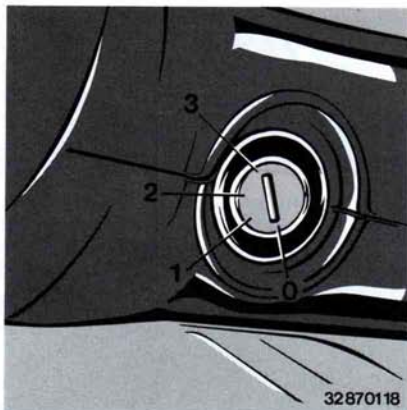

Ignition/starter switch and steering lock

0 – Steering locked.

The key can be inserted and removed in this position only.

All items of electrical equipment are switched off except for the following: side/parking lights, interior lighting, hazard warning flashers, electric seat adjustment, cigarette lighter.

To lock the steering, pull out the key and turn the steering wheel until the lock engages.

To release the steering lock, it may be necessary to turn the steering wheel slightly as the key is turned.

1 – Steering unlocked.

Further electrical equipment such as the radio and on-board computer can be operated.

2 – Ignition switched on.

All other items of electrical equipment can be operated.

Note:

A well-charged battery is necessary in order to derive maximum benefit from the car's electrical equipment. When the car is idling or driven for only a short distance, the battery is only charged to a minimal amount by the alternator. We recommend temporarily switching off equipment with a high power consumption (e.g. seat heating, heated rear window) when driving in towns or heavy traffic, if these functions are not absolutely necessary.

The memory functions of various items of equipment are supplied by a very low current; this should be borne in mind if the car remains unused for longer than 4 weeks. Before such periods, disconnect the battery at the negative terminal to prevent it from becoming discharged (see Page 86).

3 – Starter motor operated.

Do not depress the accelerator pedal while starting the engine.

On cars with automatic transmission, the engine can only be started in selector lever positions P or N.

Important notes

Never run the car's engine in an enclosed space.

The exhaust contains carbon monoxide which, although colourless and odourless, is extremely toxic. Inhaling exhaust gas constitutes a severe health risk and can lead to loss of consciousness with fatal consequences.

Never pull out the ignition key when the car is moving.

Otherwise, the ignition lock will engage and make it impossible to steer the car.

Always remove the ignition key and take it with you when leaving the car. Make sure that the steering lock has engaged.

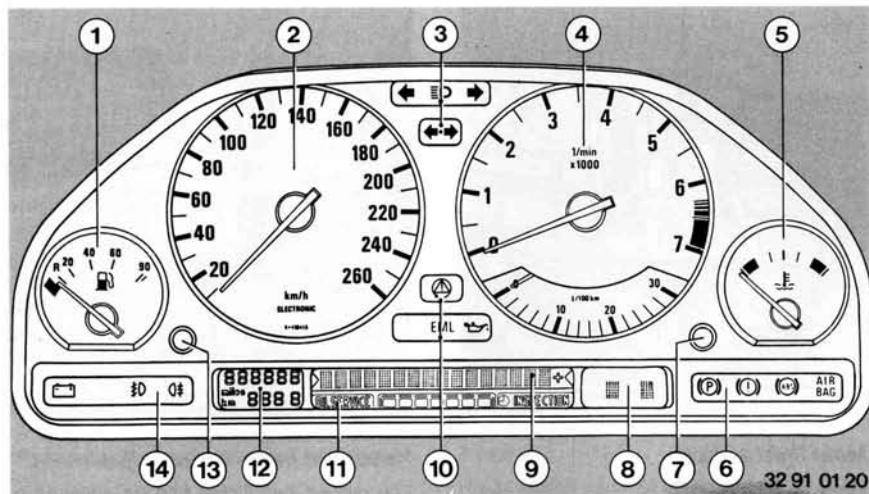

Instrument cluster

1 – Fuel gauge with telltale	Page
2 – Speedometer	25
3 – Turn indicator, high beam and trailer flasher telltales	26
4 – Revolution counter with Energy Control	24
5 – Coolant temperature gauge	25
6 – Telltale and warning lamps for handbrake, brake and steering hydraulics, antilock brake system (ABS) and AIRBAG	26, 17
7 – Check Control key	28
8 – Automatic transmission selector lever position lamps and program display	32
9 – Check control display	28
10 – Engine oil pressure, EML and ASC/ASC+T telltales	26
11 – Service Indicator	25
12 – Total and trip distance recorders	24
13 – Reset knob for trip distance recorder	24
14 – Front and rear fog light and battery charge telltales	27

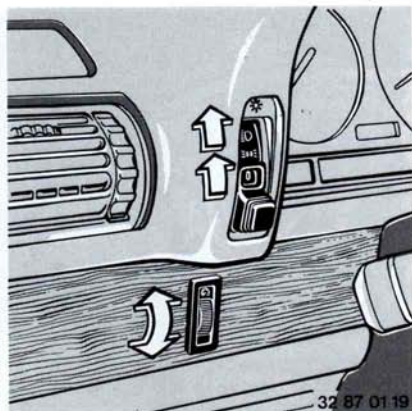

Main light switch

Stage 1: Side lights

Stage 2: Low headlight beams/xenon lights*

If the ignition is switched off with the headlights on, they will go out, but the side lights will remain on.

Xenon lights: see Page 95 for further notes.

Daytime driving-lights circuit*

If desired, the light switch can remain at stage 2: when the ignition is switched off, the vehicle lights go out.

Depending on version, the daytime driving lights come on automatically in ignition key position 2 if the light switch is at 0.

Instrument lighting

Turn the knurled wheel to adjust the light intensity.

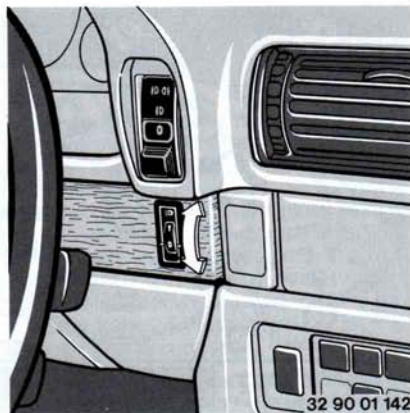

Headlight beam throw adjustment *

The dipped headlights can be adjusted to compensate for the load the vehicle is carrying.

0 = 1 – 2 persons without luggage

1 = 5 persons, with or without luggage

2 = 1 person, luggage compartment full

Note rear axle load limit.

If the headlight setting is very low, the headlight beam throw adjustment system is faulty.

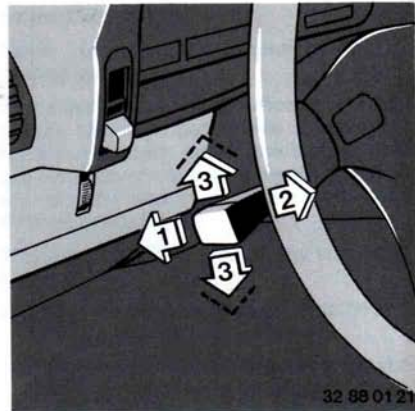

Turn indicator and high/low beam lever

1 – High headlight beam (blue telltale)

2 – Headlight flasher

3 – Turn indicators (green telltale lamp flashes and the flasher relay emits a ticking sound)

If the telltale lamp flashes faster and the ticking occurs more rapidly than normal, one of the turn indicator bulbs has blown.

Brief operation of turn indicators

When pulling away from the roadside or changing lanes, you need only move the lever slightly away from its rest position. When released, it will cancel immediately.

Parking lights, left or right

With the steering lock engaged, move the turn indicator lever beyond the normal indicating position and allow it to engage.

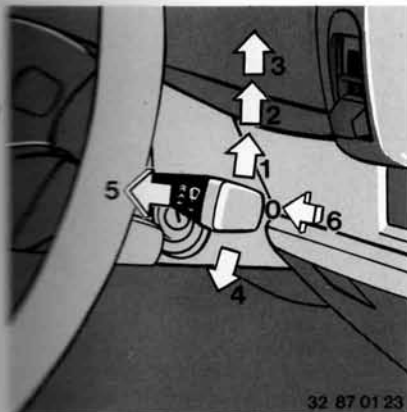

Wash/wipe system

- 1 – Intermittent wipe
- 2 – Normal wiper speed
- 3 – Fast wiper speed
- 4 – Short wipe
- 5 – Automatic windscreen wash
- 6 – Automatic intensive cleaning*

Cleaning system* for headlights and front fog lights

Every fifth time the automatic windscreen wash or intensive cleaning system is actuated, the headlights are also simultaneously cleaned if the vehicle lights are switched on.

Reservoir: see Page 83.

1 – Intermittent action

The interval depends on vehicle speed, but can also be programmed:
Wipe briefly to position 1 from position 0.

The time before the wipers are again switched on (from position 0 to position 1) is the programmed interval (max. 20 s, twice as long when the car is standing still). To cancel the programmed interval, return the lever to 0 or switch off the engine.

2 – Normal wiper speed

The wipers operate intermittently when the car is standing still.

5 – Automatic windscreen wash

Washing water is sprayed onto the windscreen and the wipers are operated briefly. (Exception: when the lever is actuated **briefly**, washing water is sprayed onto the windscreen without the windscreen wipers coming on.)

6 – Automatic intensive cleaning*

As function 5, with intensive cleaning fluid additionally sprayed onto the windscreen first.

Heated windscreen washer jets and wiper rest area of windscreen: switched on automatically when ignition key is in position 2.

Warning:

Do not use the windscreen washer if there is any chance of the liquid freezing to the glass and interfering with your view of the road and traffic ahead.

Do not operate the windscreen washer when its fluid reservoir is empty, or else the pump will be damaged.

Detach wiper blades which have frozen to the glass before operating the windscreen wipers, to avoid overloading or damaging the system.



Horn

Press airbag panel at any point.

Standard steering wheel*: press one of the horn pushes.

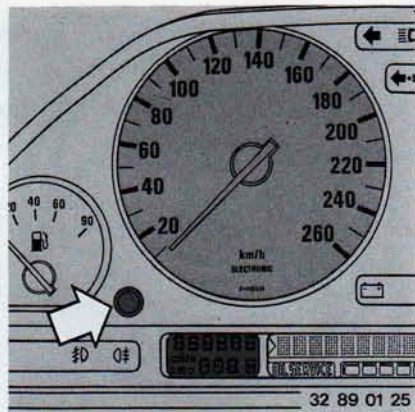

32 89 01 25

Distance recorder

Shows the total number of kilometres or miles covered by the car.

Trip recorder

Records journey distances up to 999.9 km or miles.

Press the button to reset to zero (ignition key in position 1 or beyond).

To display the distance recorder or trip distance recorder total with the ignition key removed or in position 0, press the reset button; the total will be displayed for a brief period.

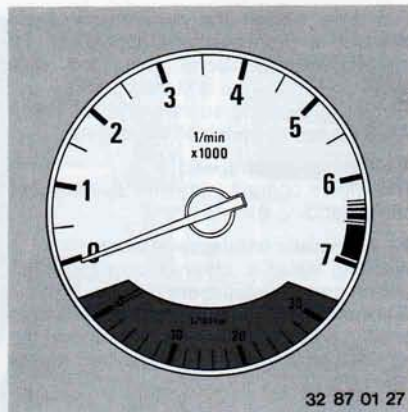

32 87 01 27

Revolution counter

Avoid engine speeds in the red warning zone.

The fuel combustion process is interrupted in this zone to protect the engine, which runs unevenly as a result.

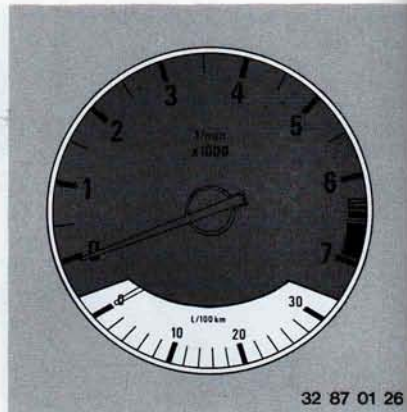

32 87 01 26

Energy Control

Shows fuel consumption in litres per 100 km and miles per gallon.

The dial clearly indicates whether or not the car is being driven economically.

When the car is idling, the needle will drift to the top end of the scale.

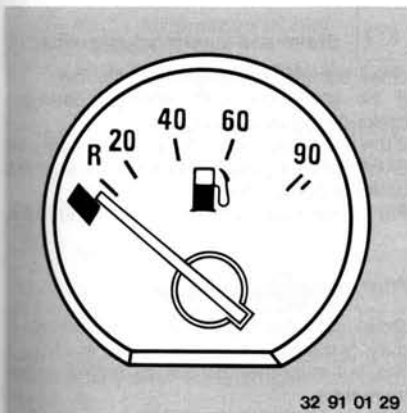

Fuel gauge

The telltale lamp comes on to indicate that there are app. 8 litres (1.75 Imp. gal) of fuel remaining in the tank.

After the ignition has been switched on, the telltale light remains on for a short period to confirm that it is operating correctly.

Fuel tank capacity: see Page 130.

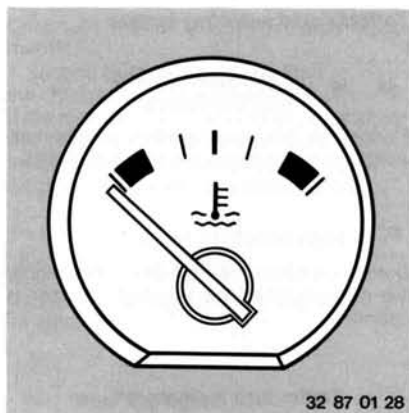

Coolant temperature gauge

Blue: engine cold. Drive at moderate engine and road speeds.

Red, "COOLANT TEMP" warning in Check Control: engine too hot. Stop the engine immediately and allow it to cool down.

Between the two coloured zones: normal operating temperature. If outside temperatures are very high or the engine has been working very hard, the needle may approach the red zone.

Checking coolant level, see Page 82.

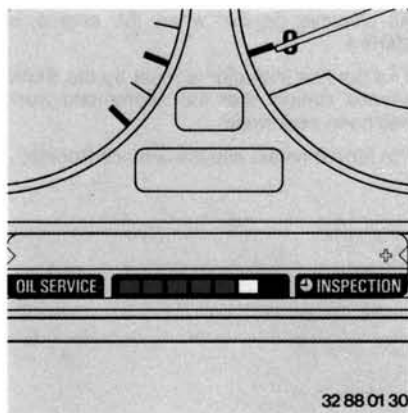

Service Indicator

Green light-emitting diodes (LED): the fewer are on, the sooner the next service will be due.

Yellow LED in conjunction with OIL SERVICE or INSPECTION: comes on when service routine is due.

Red LED: a service routine is overdue.

Clock symbol in conjunction with INSPECTION: shows that brake fluid renewal is due.

Note:

Periods during which the battery has been disconnected are ignored by the display. Any such times must be taken into account to ensure that the brake fluid is changed according to schedule (every two years or one year), i.e. it will be necessary to change the brake fluid before the clock symbol lights up.

All displays go out when the engine is started.

The Service Indicator is reset by the BMW service station after the appropriate work has been performed.

For further notes, see the Service Booklet.

Telltale and warning lamps

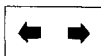

Left/right flashing turn indicators:

Flashes in the same rhythm as the turn indicators when these are being operated.



High headlight beam:

Comes on when the high-beam headlights are on and when the headlight flasher is operated.



Trailer turn indicators*:

Operates together with the vehicle turn indicator telltale when towing a trailer.

For further notes, see Page 110.



Antilock brake system (ABS):

Goes out after the engine has started. If the lamp comes on during a journey, the ABS is faulty and out of operation. The brakes can be operated conventionally, with no loss of effect.

For further notes, see Page 112.



Handbrake:

Goes out after engine has started. Comes on when the handbrake is applied.



Brake and steering hydraulics:

Goes out after the engine has started. If the lamp comes on during a journey, brake fluid level is too low. If the lamp flashes during a journey (only on BMW 750i/iL), pressure has been lost in the brake or power steering systems. For further notes see Pages 81, 80 and 93.



Engine oil pressure:

Goes out after the engine has started. It may come on when the engine is idling if hot, but must then go out as engine speed increases.

If the lamp comes on during a journey and the ENGINE OIL PRESS display is shown by the Check Control, stop the car immediately and switch off the engine. Check the engine oil level and add more oil if necessary. If the oil level is correct, consult a BMW service station.



Electronic engine output control*

Comes on briefly when the ignition is switched on, then goes out if the system is operational.

If the lamp remains on or comes on again during a journey, there is a system malfunction.

Consult a BMW service station. It may be possible to continue the journey at a low engine speed.

**ASC = Automatic Stability Control*****ASC+T = Automatic Stability Control + Traction ***

Goes out after the engine has started: system is operational.

For further notes, see Page 47.

**Fasten seat belt***

(Possibly together with acoustic signal* and/or Check Control message*.)

Comes on briefly when the ignition is switched on, then goes out (depending on version, only after the seat belt has been fastened).

**Battery charge:**

Goes out after the engine has started.

If the lamp comes on during a journey, there is a fault at the alternator V-belt or in the charging circuit so that the battery is not being charged.

Important:

BMW 730i, 740i/iL: if the V-belt is defective, the coolant pump will not be driven, and there is a risk of the engine overheating and incurring damage. Consult a BMW service station.

BMW 730i 8-cylinder model, 740i/iL, 750i/iL: if the V-belt is defective, steering effort (and braking effort on BMW 750i/iL) will be greatly increased.

Cars with High-line rear-seat area equipment*:

A second bulb in the telltale light monitors the charge current for the second alternator. If the main alternator should fail, the car can still be driven for about two hours with the telltale light on, provided that no additional electrical consumers are switched on.

**Front fog lights:**

Comes on when the front fog lights are switched on.

**Rear fog lights:**

Comes on when the rear fog lights are switched on.

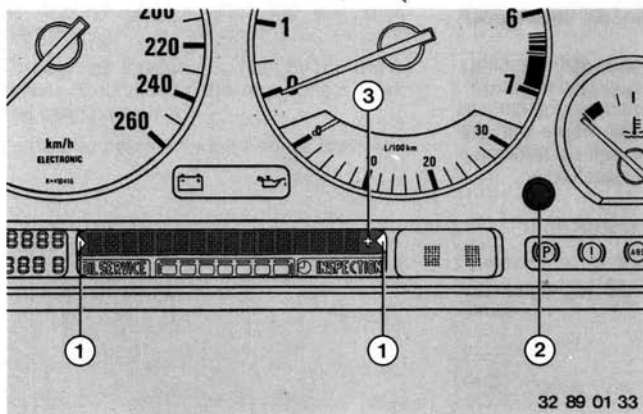

Check Control

The following system faults are displayed in the form of inscriptions, and a gong warning is sounded.

A distinction is made between three levels of priority.

Priority 1

Display	Instruction/remedy
BRAKE PRESSURE* LOW BRAKE FLUID	Too low/see Page 93 Level fallen to MIN/top up at next opportunity, see Pages 81, 93. Have the cause of brake fluid loss rectified by a BMW service station.
ENGINE OIL PRESS	Too low/stop car and switch off engine at once. See Pages 26 and 77
COOLANT TEMP	Coolant temperature too high/stop car and switch off engine at once. See Pages 25 and 82
HAND-BRAKE ON	Displayed after a minimum road speed has been exceeded

NO BRAKE LIGHT

Brake light failure – bulbs failed or fuse blown/renew bulbs or fuse (see Page 96 or 87)

BRAKE LIGHT (ELECTR.)

Brake light failure – fuse blown or circuit fault/renew fuse (see Page 87) or consult BMW service station

SUSPN LEVELLING*

Car is overloaded (rear-axle load limit exceeded) or self-levelling suspension has a fault/reduce load on car or consult a BMW service station (do not drive at more than 170 km/h [106 mile/h]) – see Page 93

Note: the SUSPN LEVELLING display alternates with a “Max. 170 km/h” warning if this speed is exceeded. This warning is cancelled if the car’s speed is reduced sufficiently below this speed.

SPEED LIMIT*

Displayed if the legal road speed limit is exceeded. Comply with local regulations.

The above faults are displayed immediately, accompanied by a warning gong and flashing reminder symbols ①.

If more than one fault occurs at once, the displays are shown in succession.

These displays cannot be cancelled with the **Check Control (CC) key** ②.

Priority 2

Display	Instruction/remedy
TRANS PROGRAM*	Automatic transmission: defect in shift electronics/see Page 33
BRAKE LININGS	Worn/see page 93
WASHER FLUID LOW	Windscreen washer fluid level has dropped/see Page 74
DOOR OPEN	Displayed after a minimum road speed has been exceeded
BOOT LID OPEN	Displayed when car is first driven away

1 BRAKE LIGHT	Bulb blown/see Page 95
DIP BEAM	Bulb blown,
SIDELIGHT*	fuse blown or
TAIL LIGHT	circuit defective/
R/FOG LIGHT*	see Pages 94 or 87,
R/FOG LIGHT*	or consult BMW
LIC. PLATE LIGHT	service station
TRAILER LIGHT*	Trailer lighting fuse blown or circuit failure/re-
	new fuse or consult BMW service station

The **displays** appear **when the ignition key is in position 2** (if priority 1 faults occur, these are automatically superimposed). After the display has gone out, the reminder symbols remain. If a **plus sign** ③ appears, this means that there are further displays which should be called up by pressing the CC key.

Note: With the CC key, displays can be cancelled before automatic cancelling takes place, and other stored displays shown by symbols can be called up.

Priority 3

Display	Instruction/remedy
ENGINE OIL LOW	Engine oil level has dropped to MIN/check oil level and top up at next opportunity (when refuelling)/see Page 77
P.A.S. FLUID*	Level too low/see Page 81
COOLANT LEVEL	Coolant is too low/top up at next opportunity, see Page 82
CHECK CONTROL	Electronics defect, various announcements cannot be indicated and/or incorrect announcements may be made/consult BMW service station at the next opportunity

OIL LEVEL SENSOR Sensor for engine oil level faulty/consult BMW service station at the next opportunity. Important: low oil level is not indicated until this fault is rectified!

LIGHT ON?* Displayed at end of journey (when driver's door has been opened)

FASTEN SEAT BELT* Possibly together with warning light* and/ or acoustic signal*.

The displays primarily appear at the end of the journey, when the ignition key has been turned back to position 0; several displays may appear in succession. Priority 3 displays are followed by those of priorities 2 and 1. Even after removing the ignition key, when the display has gone out, the information can be called up again with the CC key for about another 3 minutes.

Displays also appear before the journey starts, when the ignition key is turned to position 2; the written information disappears after a short time or when the journey is started, and no reminder symbols remain. A repeat display appears only when the ignition is returned to position 0.

If a plus sign appears: call up further displays by pressing the CC key.

General information:

If the OWNER'S HANDBOOK display appears, see "Instruction/remedy" for notes on the display concerned.

The "Owner's Handbook" display can be cancelled by pressing the CC key.

Checking operation of the Check Control display (only if no messages displayed):

Press the CC key with ignition key in position 2: the message CHECK CONTROL OK must appear.

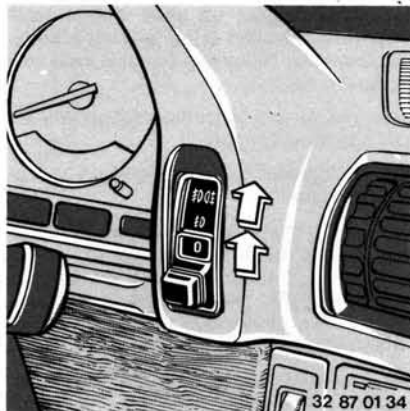

Front fog lights

The green telltale lamp in the instrument cluster comes on when the front fog lights are switched on.

Rear fog lights

The yellow telltale lamp in the instrument cluster comes on when the rear fog lights are switched on.

Please note national regulations with regard to the use of fog lights.

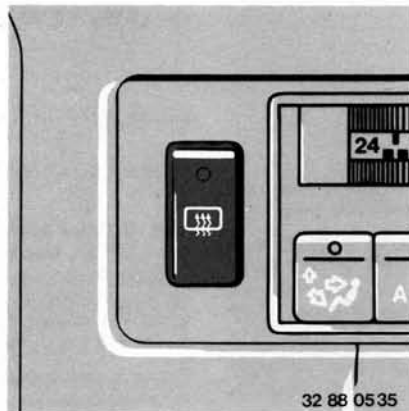

Heated rear window

Press the button: the heating circuit runs at its full output rating when the telltale lamp is on (for rapid defrosting).

When the lamp goes out, the circuit has switched over to the economy rating and cuts out after app. 20 min.

If necessary, press the button again: a new operating cycle commences with rapid defrosting as before.

To switch off, press the button again when the lamp is on.

Note: if the rear-window heating function is not needed, switch it off to save current, particularly on short journeys when alternator output is low.

Every time the engine is restarted, the rear window heating has to be switched on again as required.

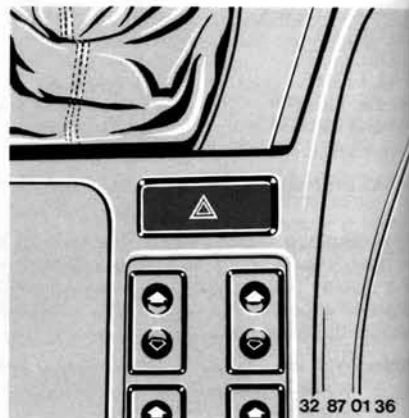

Hazard warning flashers:

The red telltale lamp in the pushbutton with the triangle symbol flashes rhythmically when the hazard warning flashers are switched on.

When the car's lights are switched on, a locating bulb comes on in the pushbutton for the hazard warning flashers.

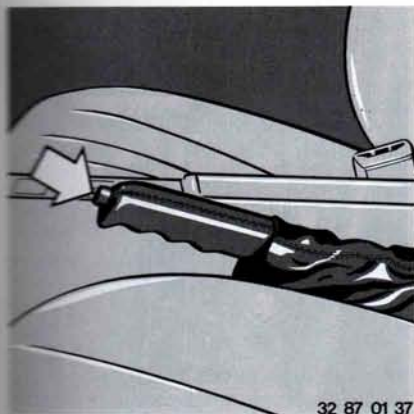

32 87 01 37

Handbrake

The handbrake lever engages automatically when pulled up, and the "P" telltale lamp in the instrument cluster comes on.

To release the handbrake, pull the lever up slightly, press in the knob and push the lever fully down.

The handbrake acts on the rear wheels. Do not apply it too hard when the car is being driven, to avoid excessive rear-wheel braking and the possibility of the rear of the car skidding.

Note:

The brake lights do not come on when the handbrake is applied.

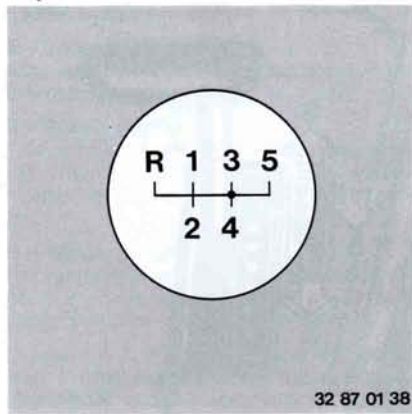

32 87 01 38

Manual gearbox

The rest position for the gear lever is in the 3rd/4th gear plane. When the lever is moved out of gear, it springs automatically to the rest (neutral) position.

All ratios are equipped with synchromesh.

Warning:

At an engine speed of greater than 5000 min^{-1} in 5th gear, do not shift back down to 4th gear, otherwise you risk causing damage to the engine.

Selecting reverse

With the car standing still, press the gear lever to the left until the slight resistance is overcome.

Reversing lights

These come on when reverse gear is selected and the ignition is switched on.

Warning:

On a gradient, do not try to keep the car still by slipping the clutch. Always apply the handbrake. A slipping clutch will suffer premature and excessive wear.

Warning:

Please do not drive the car if you are under the influence of alcohol. Even small amounts of alcohol or drugs can adversely affect your perception, your judgement, your powers of decision and your reflexes, particularly if taken at the same time as medicines.

The risk of severe or even fatal accidents, possibly involving innocent parties, is very much higher in such circumstances.

Do not allow any other persons, even those well known to you, to drive the car if you are aware that they have consumed alcohol or taken drugs.

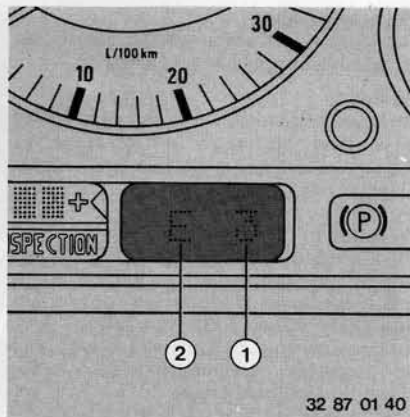

32 87 01 40

Automatic transmission *

Selector lever positions (1):

BMW 730i 8-cylinder, 740i/iL:
P R N D 4 3 2

BMW 730i 6-cylinder, 750i/iL:
P R N D 3 2 1

3 different shift programs (2) can also be selected at the program switch:

BMW 730i 8-cylinder, 740i/iL:
E Economy – press switch
S Sports – push switch in
* Winter – desired direction

BMW 730i 6-cylinder, 750i/iL:
E Economy – press switch
S Sports – push switch in
M Manual – desired direction



BMW 730i 8-cylinder, 740i/iL

Please note:

The engine can be started in position P or N only.

Press the release catch under the selector lever handle; this lever prevents certain lever positions from being engaged inadvertently.

After selecting a speed range, wait for the transmission to engage (you will notice a very slight jerk) before accelerating.

The car tends to creep forwards (or backwards) if the engine is running at idle speed and a drive ratio is engaged.

If you shift accidentally from a drive ratio to N, always take your foot off the accelerator pedal immediately and then select the desired ratio.

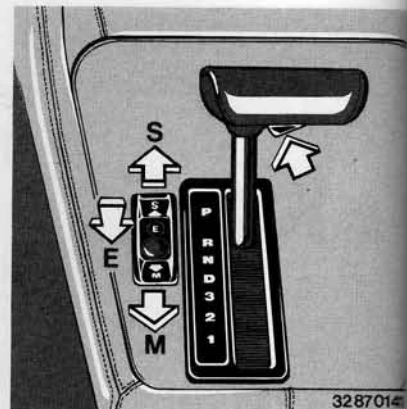

BMW 730i 6-cylinder, 750i/iL

Before leaving the car with the engine running, first select P or N and engage the handbrake.

P – Park

Select only when the car is standing still. The rear wheels are locked.

R – Reverse

Only engage when the car is stationary and the engine at idle speed.

N – Neutral (idling)

Select when the car is stopped with the engine running for any length of time. When the car is moving, select N only to counteract skidding.

D – Drive (automatic)

The normal driving position with automatic transmission.

4 – direct drive

(BMW 730i 8-cylinder, 740i/iL)

3 – direct drive

(BMW 730i 6-cylinder, 750i/iL)

Select this position if road or traffic conditions cause the transmission to hunt between 5th and 4th gears (BMW 730i 8-cylinder, 740i/iL) or between 4th and 3rd gears (BMW 730i 6-cylinder, 750i/iL).

4th and 5th gear are not used.

3 and 2* – Hill climbing and engine braking (BMW 730i 8-cylinder, 740i/iL)

2 and 1 – Hill climbing and engine braking (BMW 730i 6-cylinder, 750i/iL)

Select these positions on mountain roads and very long uphill and downhill gradients. They make better use of the engine's performance and braking action, and prevent undesired up-shifts.

Positions can be selected at any speed. However, the transmission will not shift down until a suitably low speed is reached in each case.

Kickdown

The accelerator pedal can be depressed beyond the full-throttle position by overcoming a detent.

Up to a certain speed range, the next lower ratio is selected to provide improved acceleration. The next upward shift does not take place until a much higher engine speed has been reached.

* 2nd gear is automatically selected. In view of its special settings, this position is especially suitable for trailer towing.

Shift programs**E – Economy program**

After starting the car, select this program for low-consumption motoring.

S – Sports program

This is the program for an enthusiastic driving style. Upward gear shifts are delayed to make fuller use of the engine's power output.

*** – Winter program**

For winter driving conditions. In position D, gears 2 – 5 are selected in such a way as to improve traction in wintery conditions¹⁾.

In positions 4, 3 and 2 the selected gear is held. In other words, you can also pull away in this gear, and the transmission does not shift down after acceleration.

On inclines or when towing a trailer, for example, it is beneficial to drive in selector lever position 2; in wintery conditions on icy roads, position 4 is recommended for pulling away smoothly with no gear shifts.

M – Manual-shift program

For driving conditions in which the selected gear is to be retained. In other words, the selected gear is also used for pulling away and accelerating. In this program, only 3rd gear is used in position D.

On inclines or when towing a trailer, for example, it is beneficial to drive in selector lever position 1 or 2; in wintery conditions on icy roads, position 3 is recommended for pulling away smoothly with no gear shifts.

If the TRANS PROGRAM display appears in the Check Control, there is a fault in the electronic shift system or transmission.

All selector lever positions remain available for use, and the transmission will select 4th or 5th gear in the positions for forward travel.

BMW 730i 6-cylinder, 750i/iL: in order to continue driving in 3rd gear to derive maximum benefit from the engine's power, the engine should be switched off when the car is stationary and started up again.

In this event, avoid extreme engine loads and consult the nearest BMW service station.

Note:

If this display appears or the transmission is faulty, the car must not be driven and must be taken to a BMW service station for repair.

Warning:

Never carry out any work in the engine compartment when a gear (speed range) has been selected. Never leave children unattended inside the car.

For towing away, tow-starting and starting with a flat battery see Pages 94, 93.

¹⁾ BMW 740i – Switzerland version: in the engine's warming-up phase, the car pulls away in 1st gear.

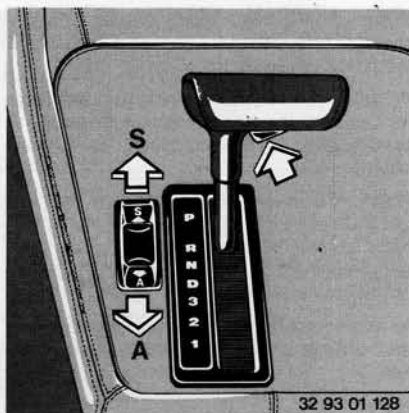

Adaptive transmission control* (AGS) – BMW 750i/iL

Two programs can be selected at the program switch:

- A – “Adaptive” program
- S – “Sports” program

Push the switch in the desired direction. The selected program is then displayed in the instrument cluster (see Page 32).

A – “Adaptive” program

This is the initial position every time the engine is started. When a forward speed is selected, the adaptive transmission control automatically selects the most advantageous shift program. The control system adapts continuously to the driver's style (e.g. restrained or enthusiastic approach), the properties of the road surface (e.g. slippery surface or sharp incline) and the momentary driving situation (e.g. curves or downhill gradient).

S – “Sports” program

In this position, only the most dynamic shift program is used.

This program is recommended if performance-oriented speed selection is desired, independent of the momentary driving style.

Selector lever positions

The selector lever positions are described on Page 32. However, the function of positions 3, 2 and 1 more resembles that of a speed limiting device which can therefore be deliberately chosen.

When in position **3 – direct drive** – the transmission may hunt between 4th and 3rd in position D. This effect does not occur with AGS.

The AGS also functions in selector lever positions 3, 2 and 1, with certain limitations on the available gears, depending on the position selected.

Special functions

In program A, the adaptive transmission control influences speed selection by means of various special functions.

Certain shifting processes which were previously common are now suppressed, and in special situations gear shifts which previously did not occur now take place.

Suppressing upshifts

If the accelerator is let out rapidly while cornering at high speeds and on steep downward gradients, upshifts are usually suppressed. The engine's braking effect can thus be used and the occurrence of undesirable upshifts when the car is being driven in an enthusiastic manner is significantly reduced.

Shifting down

The comments on Page 33 on the kickdown function also apply to the AGS. In many instances, however, depressing the accelerator pedal rapidly will be sufficient to cause the transmission to shift down; it will then not be necessary to bring the kickdown function into operation.

If the vehicle is braked on a sharp downhill gradient, up to a certain engine speed the transmission shifts down a gear. This increases the engine's braking effect.

Note:

Rear passengers, in particular if reading, may experience abrupt deceleration as disagreeable or even unpleasant.

At higher speeds (above approx. 150 km/h), undesirable downshifts can be avoided and gentle acceleration achieved by gradually depressing the accelerator as far as the full-throttle position.

Suppressing downshifts

When cornering at high speeds and with very high lateral acceleration, critical driving situations could be encountered if downshifting occurs. Downshifts are therefore largely suppressed.

Selection of winter driving program

When driving on a slippery surface (snow and ice), a winter program is automatically selected. The car pulls away in 2nd gear and shifts up to higher gears at relatively low speeds. This program facilitates driving in wintery conditions, and the vehicle's traction and dynamic stability are enhanced.

The winter program is left whenever the AGS recognises that the car is on a high-grip surface, the "Sport" program is selected or the ASC+T is switched off.

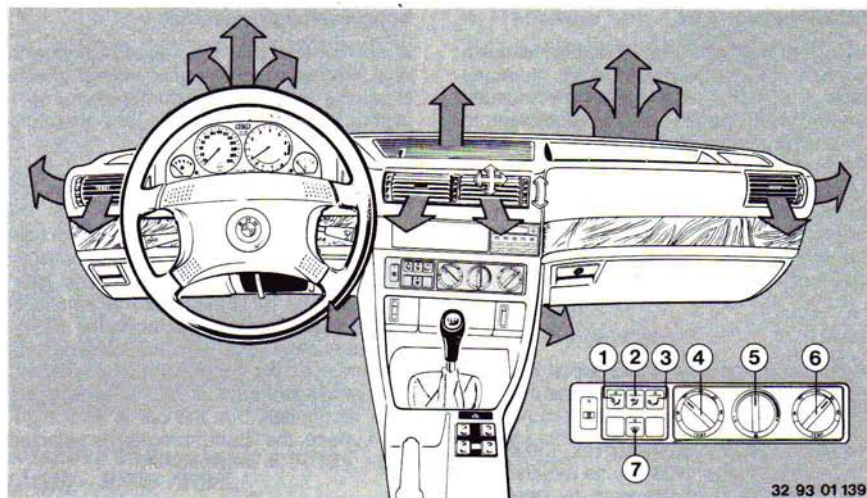

Heating and ventilation

- 1 – Pushbutton for upper air distribution
- 2 – Pushbutton for centre air distribution
- 3 – Pushbutton for lower air distribution
- 4 – Rotary temperature selector, left side
- 5 – On/off and rotary airflow volume control
- 6 – Rotary temperature selector, right side
- 7 – Pushbutton for maximum windscreen and side window defrosting

Wherever a button is pressed, the corresponding LED lights up if the system has been switched on at rotary airflow volume control (5).



Pushbutton for upper air distribution

Air emerges through the defroster outlets for the windscreen and the front side windows.



Pushbutton for centre air distribution

Air emerges through the directionally adjustable, controlled-flow grilles in the front of the fascia and the controlled-flow grille on top of the fascia.



Pushbutton for lower air distribution

Air emerges through the front footwell outlets and the outlets supplying the rear passenger area.

To prevent the windows from misting over, a small amount of air emerges through the defroster outlets.

4, 6 – Rotary temperature selectors for left/right sides

Temperature control is switched on and off at the rotary knob on the **driver's side**:

Anticlockwise limit position: no heating effect, temperature control off.

As the control is turned clockwise away from the detent position: temperature control cuts in.

Clockwise limit position (detent): maximum heating output and temperature control off (also emergency position if a fault develops in the electronic temperature control system).

The calibrations are intended as an approximate guide to the temperature inside the car. The selected temperature is reached as soon as possible after the car has been started, and does not normally need to be altered.

Alter the setting only by a small amount at a time, to prevent excessive temperature fluctuations.

5 – On/off and rotary airflow volume control

Position 0: system switched off, air entry shut off.

Turned clockwise from detent to position 1: minimum blower rating.

Turned further to right: airflow volume increases.



Pushbutton for maximum windscreen and side window defrosting/drying

If the windows fog over, this is usually caused by severe temperature differences (condensation) or by high atmospheric humidity. The only cure is to dry the glass by increasing the flow of air and its temperature.

When this button is pressed, maximum windscreen and side window defrosting is selected automatically, with no additional control movements needed. Maximum defrosting effect is not obtained until the engine reaches its normal operating temperature.

When this button is released, the previous control settings are automatically restored.

Note: when this button is pressed, rear window heating is also in operation.

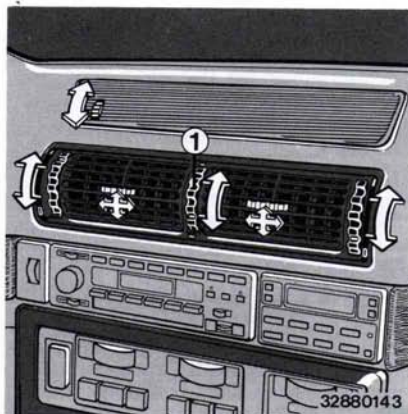

Stratified temperatures for freedom from fatigue on long journeys: feet warm, head cool

Driver and front passenger: knurled wheel 1 varies the temperature of the air emerging from all fascia grilles.

Up: warmer
Down: cooler

Rear-seat passengers: open and alter the direction of the grilles at the rear end of the centre console as required. These grilles supply fresh air only.

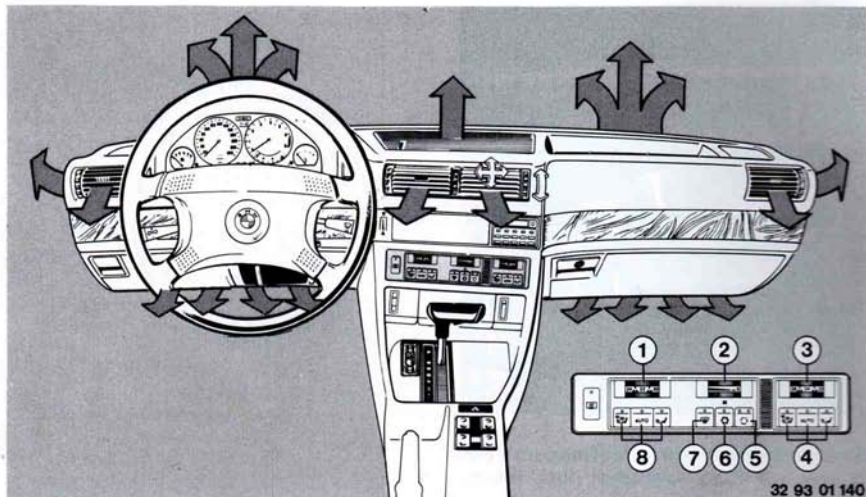

Air conditioning *

- 1 – Temperature selector wheel, left side
- 2 – On/off and airflow volume control
- 3 – Temperature selector wheel, right side
- 4 – Passenger's side air distribution program keys
- 5 – Pushbutton for automatic recirculated-air control* or recirculated-air operation
- 6 – Pushbutton for air conditioning
- 7 – Pushbutton for maximum windscreen and side window defrosting
- 8 – Left side air distribution program keys

When a pushbutton is pressed, the corresponding LED lights up if the system has been switched on at airflow volume control selector wheel (2).

1, 3 – Left/right side temperature selector wheel

Temperature control is switched on and off at the selector wheel on the **driver's side**: Left-hand limit position: no heating effect, maximum cooling effect, temperature control off.

As the control is turned to the right away from the detent position: temperature control cuts in.

Right-hand limit position (detent): maximum heating output and temperature control off (also emergency position if a fault develops in the electronic temperature control system).

The calibrations are intended as an approximate guide to the temperature inside the car. The selected temperature is reached as soon as possible after the car has been

started, and does not normally need to be altered.

Alter the setting only by a small amount at a time, to prevent excessive temperature fluctuations.

2 – On/off and airflow volume control Position 0: system switched off, air entry shut off.

Turned to the right to detent: system on, minimum blower rating.

Turned further to right: airflow volume increases.

Right-hand limit position (detent): maximum airflow volume (also emergency position if a fault develops in the electronic blower control system).

4, 8 – Left/right side air distribution program keys

 Air distribution takes place automatically in accordance with the temperature situation.

Air outlets: through the defroster outlets to the windscreen and front side windows, through the directionally controllable, variable-flow grilles on the fascia and the variable-flow grille on the top of the fascia, to the front footwell outlets and the outlets for the rear passenger area and through the directionally controllable, variable-flow rear-seat ventilation grilles at the rear end of the centre console.

After a cold start in cold weather and until the heater matrix has reached 30°C, air emerges from the defroster outlets only.

This program is suitable for all normal conditions with very few exceptions, and supplies air to the interior at a pleasant and acceptable temperature.

For optimum operation of the automatic air distribution system, the facia grilles must not all be closed at the same time.



Air supply to all outlets and grilles, without automatic air distribution control.

This program is recommended for warmer weather in particular, when special ventilation or cooling of the lower part of the car's interior is required.

Note:

Press this button, increase the airflow if necessary and close up the ventilation outlets if the windscreen and side windows mist over during a journey and you do not wish to press button 7.



Air distribution to front and rear footwell outlets only.

The defroster outlets are only slightly open, and no air reaches the grilles at the rear end of the centre console.

This program is recommended in cooler weather, for example when no fresh-air ventilation is required or to warm up the footwell area quickly.



Pushbutton for automatic recirculated-air control*

This system identifies extreme air pollution in the atmosphere and prevents the air outside from penetrating into the passenger compartment.

By pressing this button repeatedly, three functions are called up:

– LEDs off: normal fresh-air mode

– Left LED on: the pollution level of the outside air is being monitored by a sensor.

If excessive, the fresh-air outlets are automatically closed and the system switches to recirculated-air control.

– Right LED on: recirculated-air control.



Pushbutton for recirculated-air operation

Recommended when driving through badly contaminated outside air. The air inside the car is recirculated and no outside air permitted to enter.

Although the air conditioning is automatically switched on to improve the quality of the air by removing excess moisture, the recirculated-air setting should not be used for too long at a time.

Note: if the windscreen and side windows should mist over in the recirculated-air mode or with the automatic recirculated-air control on, select the normal fresh-air mode and switch on the air conditioning with pushbutton 6.



Pushbutton for air conditioning

When this button is depressed, the air conditioning is switched on in all programs at an outside temperature of approx. +1°C and above. The air is cooled and dried.

If atmospheric humidity is very high, it is best to run the air conditioning without delay (before moisture condensate can reach the evaporator) to dry the air and prevent the

windows from fogging over. Take care not to direct **cooled** air onto the windscreen, as it could otherwise mist over on the outside.

If maximum cooling performance is needed, the system switches automatically to recirculated-air operation (with a small proportion of additional fresh air), and the defroster outlets are closed.



Pushbutton for maximum windscreen and side window defrosting/drying

If the windows fog over, this is caused by temperature differences (condensation) or by high atmospheric humidity. The only cure is to dry the glass by increasing the flow of air and its temperature.

When this button is pressed, maximum windscreen and side window defrosting is selected automatically, with no additional control movements needed.

Maximum defrosting effect is not obtained until the engine reaches its normal operating temperature.

When this button is released, the previous control settings are automatically restored.

Note: when this button is first pressed after the engine has been started, rear window heating is also in operation.

Noises heard after the engine has been switched off are caused by the actuating motors returning the ventilation flaps to their rest positions.

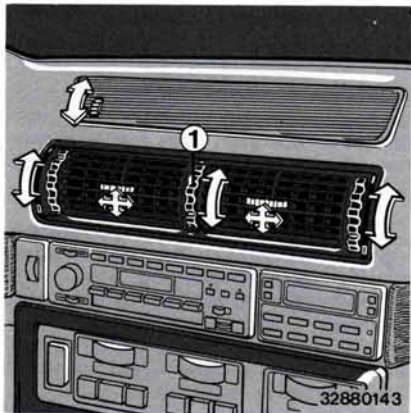

Stratified temperatures for freedom from fatigue on long journeys: feet warm, head cool

Driver and front passenger: knurled wheel 1 varies the temperature of the air emerging from all facia grilles (except when maximum cooling performance has been selected).

Up: warmer
Down: cooler

Rear-seat passengers: open and alter the direction of the grilles at the rear end of the centre console as required. These grilles supply fresh air only (cooled air if the air conditioning is in operation).

Rear-seat area ventilation is shut off automatically in the driver's-side programs
– AUTO (cold weather only) and
– air distribution to footwell outlets only.

Important notes on air conditioning operation

1. The moisture condensate which forms at the evaporator is discharged underneath the car. Depending on humidity, up to 2 litres of water may be discharged per hour.
2. The air conditioning must be run briefly at least once a month to prevent the compressor shaft seals from drying out and allowing refrigerant to escape. This is particularly important during the winter.
3. If any malfunction occurs in the air conditioning system, for instance if it is set for maximum cooling (driver's side temperature selector wheel fully to left) but no cooled air is supplied, it must be switched off immediately and the car taken to a BMW service station.

Microfilter*

Fresh air is drawn in through a microfilter. This traps up to 100% of all pollen and up to 60% of dust particles in the air.

The filter is changed at the car's regular servicing intervals. However, if airflow is noticeably lower than usual, this may indicate that the filter should be renewed earlier.



32 87 0146

Interior light/footwell lights

- 1 - Lights on when a door is open (door contact switches) and remain on for several seconds after the door has been closed, even with the ignition off, and after an accident
- 2 - Lights permanently off
- 3 - Lights permanently on

The reading lights next to the front interior light are operated similarly.

Automatic interior light

The light comes on when the driver's door handle is lifted (max. three times) and goes out again a few seconds after the door is closed or when the ignition is switched on.

If the car's lights were switched on, the interior light comes on when the ignition switch is turned off and is switched off again a few seconds after the doors have been closed.

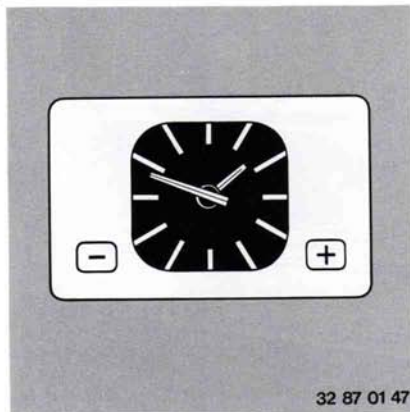

32 87 0147

The rear seat reading lights can be operated by switches next to them when ignition key is in position 1 or beyond.

Analog clock

- + key: to move the hands clockwise
- key: to move the hands counterclockwise

If the key is touched briefly: the minute hand is reset by one minute.

If the key is pressed firmly, adjustment is continuous; the longer the key is pressed, the faster the hands move.



32 93 0148

Ashtrays

Front ashtray

Touch the ashtray at the top; it will slide out automatically.



Cigarette lighter

Press the knob (1) to operate. When the spiral element has heated up, the lighter jumps out to its original position and can be removed.

Warning:

Always take hold of the cigarette lighter by its knob, never by its heating element or at the sides.

To extinguish a cigarette, first knock off excess ash, then insert it into the funnel-shaped section of the ashtray. Do not press it in hard.

Emptying the front ashtray:

Move the lever in the direction of arrow (2). The ashtray can now be removed.



Emptying the rear ashtrays:

Open the ashtray and lift it out.

Cigarette lighter for rear-seat passengers: at rear end of centre console.

Warning:

The cigarette lighters can still be used when the ignition key has been removed. For this reason, never leave children unattended in the car.

Cigarette lighter socket

This can also be used as a power socket for a hand lamp, car vacuum cleaner etc. rated up to app. 12 V, 200 Watt.

Be careful not to damage the socket by inserting a plug of the wrong pattern.

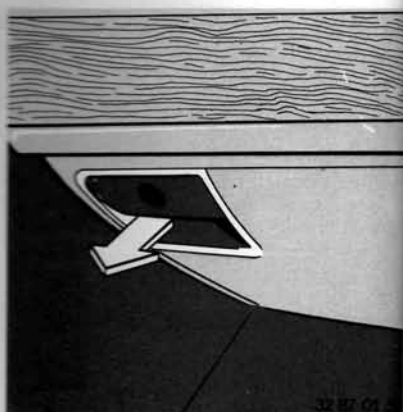

Glove box

Open by pulling the handle; the light comes on when ignition key is in position 1 or beyond.

The glove box can be swung down and pulled out for better access from the driver's seat.

Close by swinging back in and pushing the lid up.

Warning:

To avoid the risk of injury, close the glove box immediately after use.

Lock with a master key.

To renew the light bulb (5 Watt), press the clip holding the light with a screwdriver blade and pull out the light.

Rechargeable hand lamp*

The lamp is located in the left of the glove box. It has a built-in overload cutout and can therefore remain plugged in all the time, so that it is fully charged whenever needed.

Warning: do not plug the lamp in while it is switched on.

Other storage compartments:

Hinged compartment with tray for parking-meter coins on left at side of steering column.

can be locked in the same way as the glove box.

There are further storage spaces in the door armrests and behind the front seat backs.

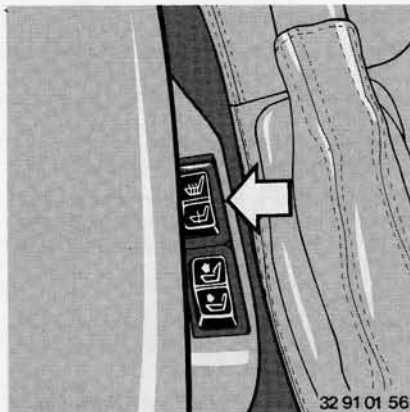

Rear-seat heating*

The rocker switches are at the end of the centre console, under the ventilation grilles.

In view of its high power consumption, do not operate the seat heating for longer than necessary.

Electric seat heating *

Seat cushion and seat back can be heated when the ignition key is in position 2.

Press the rocker switch with heating symbols:

- Press the desired symbol on the switch:
- ⋮ Rapid heating while the symbol is illuminated. Automatic changeover to regular heating.
 - } Regular heating. Cuts out automatically when the switch is no longer illuminated.

To switch over while heating: press the non-illuminated switch symbol.

To switch off prematurely: press the illuminated section of the switch.

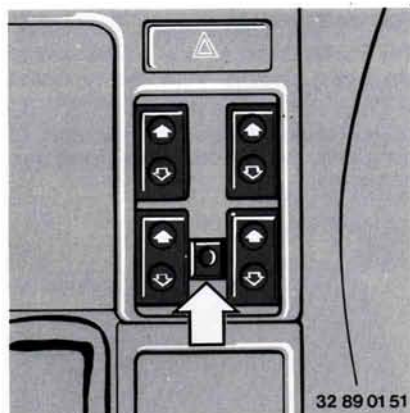

Electric window lifts

Individual switches are provided under the rear door windows.

To operate, the ignition key must be in position 2.

One-touch function*: by touching the appropriate switch momentarily, the driver's door window can be opened or closed and the other windows opened. A further touch halts window movement.

Safety switch (arrow)

To prevent operation of the rear windows at the door switches, e. g. by children.

Convenience circuit

After the ignition has been switched off these can still be operated (for a maximum of approx. 15 minutes) when

- the key is in position 1 or 0,
- the key has been removed, or
- the doors have been opened once.

After the doors have been closed, hold the key in the door in either locking position to close the windows (convenient closure function).

Warning:

Careless or negligent closing of the windows, particularly with the remote control, could cause injury.

If children are carried on the rear seat it is particularly important to keep the safety switch (arrow) pressed in.

Always remove the ignition key and take it with you when leaving the car.

An electronic automatic circuit breaker protects the system against overloading and faults.



Sliding/tilt roof*

Operate in ignition key position 2.

Raising: press the switch.

Opening: slide the switch to the rear.

Closing: slide the switch forwards.

One-touch function*: to open or close a partly-open sunroof, just operate the switch briefly in the desired direction. A further touch halts the movement.

To prevent unpleasant draughts of air or a feeling of low air pressure inside the car when the sliding/tilt roof is slid open keep the air entry grilles open and increase the incoming airflow if necessary.

Convenience circuit

After the ignition has been switched off it can still be operated (for a maximum of approx. 15 minutes) when

- the key is in position 1 or 0,
- the key has been removed, or
- the doors have been opened once.

After the doors have been closed, hold the key in the door in either locking position to close the sliding/tilt roof (convenient closure function).

Warning:

Careless or negligent closing of the sliding/tilt roof, particularly with the remote control, could cause injury.

Always remove the ignition key and take it with you when leaving the car.

An electronic automatic circuit breaker protects the system against overloading and faults.

If an electrical fault should develop, the electric sliding roof can be closed manually (see Page 94).

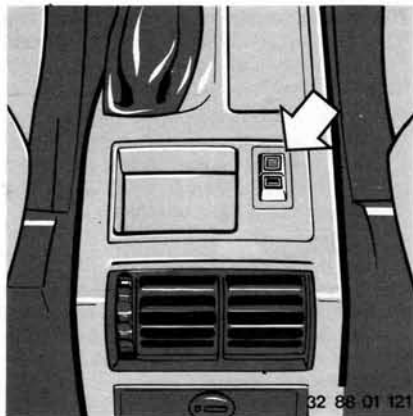

Electrically operated roller sun blind for rear window*

Touch the rocker switch momentarily to actuate.

Roller sun blinds for rear side windows*

Pull the blind out at its loop and attach it to the retainer.

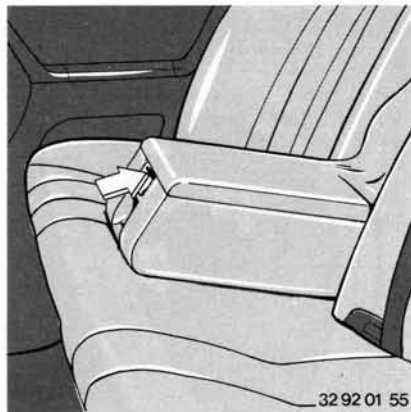

Rear centre armrest

To open the storage compartment, lift the catch at the front, under the lid.

Front armrests*

To release the catch, press the button on the front.



Automatic cruise control *

Any desired driving speed above app. 40 km/h (25 mile/h) can be held constant and memorised.

1 – ACCEL.

Moving the lever briefly in this direction:

The car's road speed is maintained and memorised. Each time the lever is moved again in this direction, the road speed is increased by app. 1 km/h.

Holding the lever in this position:

The car accelerates although the accelerator pedal is not pressed down. As soon as the lever is released, the road speed then reached is maintained and memorised.

The controlled speed is abandoned and must be selected again if the car exceeds the memorised value by more than 10 km/h for longer than 1 minute.

On cars with ASC (Automatic Stability Control) or ASC+T (Automatic Stability Control + Traction), when the set value is exceeded by 16 km/h or undercut by 8 km/h, the memorised value must be reset.

2 – DECEL.

Holding the lever in this position:

The throttle is automatically closed to slow the car if it is already moving at a controlled speed. When the lever is released, the speed the car has then reached is maintained and memorised.

On cars with ASC or ASC+T, the car will slow down (throttle closed automatically). The speed reached when the lever is released is then maintained and memorised.

Moving the lever briefly in this direction:

Each time the lever is moved, the car slows by app. 1 km/h if it is already moving at a controlled speed.

On cars with ASC or ASC+T: the speed is held and memorised. Each time the lever is moved briefly in this direction, the car's speed is reduced by app. 1 km/h.

3 – RESUME

Moving the lever briefly in this direction:

The speed last memorised is recalled and maintained.

4 – OFF

Moving the lever briefly in this direction: **The cruise control is switched off, regardless of any other operating conditions or the traffic situation.**

The cruise control is also switched off if the car decelerates at more than 1.5 m/s², for instance on gradients, whenever the brakes are applied or the clutch pedal depressed (manual gearbox cars) or the automatic transmission selector lever moved from D to N.

The memorised speed setting is erased when the engine is switched off.

Warning:

Do not use the automatic cruise control:

- on twisting roads
- if heavy traffic does not permit you to maintain a constant speed
- if the road surface is slippery (snow, rain, ice) or loose (stones, sand).

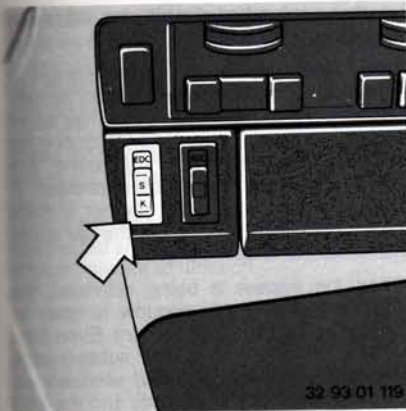

Electronic Damping Control (EDC) *

This system ensures automatically that the desired degree of suspension damping is provided, and thus enhances both safety and ride comfort.

Switch positions:

K – "Comfort" program
S – "Sport" program.

The driver can switch from one program to the other at any time.

In ignition key position 2, the selected position is illuminated.

The selected program can be retained throughout the car's speed range and with any load on the car. If the influencing factors vary (road surface quality or operating conditions such as steering, braking, etc.), the damping force is adjusted in a few fractions of a second to suit the new situation.

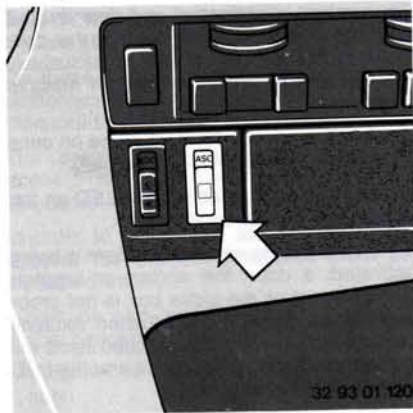

Automatic Stability Control (ASC) */Automatic Stability Control plus Traction (ASC+T) *

These systems improve driving stability, particularly when accelerating and cornering.

They prevent the driven wheels from spinning when driving conditions are unfavourable (smooth or slippery road surface), and ensure that the maximum possible amount of power can always be transmitted through the tyres to the road.

The system is ready to operate whenever the engine is started.

The telltale light in the instrument panel goes out after the engine has been started.

To switch off the system:

Press the button; the telltale light will come on.

To switch the system on again:

Press the button a second time; the telltale light will go out.

If the telltale light flashes:

The system is active, that is to say it is compensating for fluctuations in traction caused by the road surface.

If the telltale light does not go out after the engine has been started or comes on during the journey:

The system is defective, but the car itself is fully operational with the exception of the ASC/ASC+T stability control function. Consult a BMW service station regarding repair of the fault.

For further information, see Page 113.

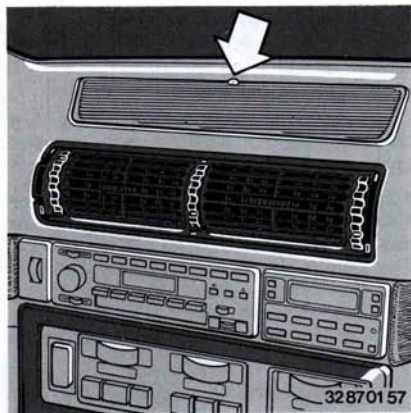

Acoustic-signal burglar alarm *

If an unauthorised person attempts to open a door or lid, an alarm sounds for 30 seconds and the ignition is put out of action. In addition, the low-beam headlights flash* with the hazard warning flashers* for 5 minutes (if permitted by law).

If he is not deterred and tries, for example, to start the engine or interfere with the radio, glove box or battery, the alarm sounds for a further 30 seconds each time such an attempt is made.

If the car is pushed away, the alarm sounds after a short distance.

The system is **activated and deactivated** with the thiefproofing device via the door locks or the remote control, or exclusively via the remote control on certain national versions.

The hazard warning flashers come on once to confirm that the system is active*.

When the system is active, the LED on top of the fascia flashes continuously.

If the LED flashes when the system is being activated, a door, the engine or luggage compartment or the glove box is not properly closed. Even if this situation remains uncorrected, the remaining closed items will be protected after 10 seconds and the LED flashes continuously.

The LED goes out when the system is deactivated.

If the alarm has been triggered off, the LED subsequently flashes continuously. When the system is deactivated the LED flashes for 10 seconds to indicate that the car has been tampered with.

The **luggage compartment** is still accessible with the system activated. The LED flashes for 10 seconds as a reminder if the luggage compartment lid has been closed but not locked (to lock, turn key to right and pull out).

Interior protective circuit and tilt alarm sensor

If the rear window or a side window is smashed (all side windows should be kept closed, but a gap of up to 10 mm may be left in order to ventilate the interior during hot weather), again the alarm will sound. The same applies if the vehicle's position or angle is altered (e.g. if an attempt is made to remove the wheels or tow the car away, the tilt sensor is activated).

When the system is being activated, the LED flashes if a side window is open by more than the permitted amount. Even if the window in question is not subsequently closed, the remaining closed windows will be protected after 10 seconds and the LED flashes continuously.

To prevent an **unwanted alarm signal being set off by the tilt alarm sensor**, for example when the car is carried on a train, the tilt alarm sensor can be overridden: Immediately after activating the anti-theft alarm system, repeat the activating routine (in other words turn the key to the thiefproofing position a second time or operate the remote control a second time).

The LED will come on for a short time, then flash continuously. The tilt alarm sensor is then out of action.

Note: if door loudspeakers are fitted improperly, the functioning of the window protective system may be impaired.

Important:

As far as possible, do not interrupt the convenient-closing process for windows and the sliding/tilt roof by activating the thief-proofing device.

If this process is interrupted within the first 10 seconds and then restarted, the tilt alarm sensor will simultaneously be inactivated as a result.

If this is the case, the system will have to be deactivated and then activated again for the tilt alarm sensor to function.

Anti-theft alarm system on models with double glazing*

On these models, the interior is protected ultrasonically instead of the windows being monitored.

The system is operated as described above. The following points should in addition be noted:

In order to avoid false alarms, the **alarm system for the car's interior** must be **switched off** if

- persons, pets or any moving objects (e.g. coat hangers) remain in the car
- windows or the sliding/tilt roof are left open.

It is deactivated along with the tilt alarm sensor as described two columns earlier on.

The alarm system for the car's interior is automatically switched off if

- the luggage compartment is opened
- the independent heating/ventilation is in operation.

If the system cannot be de-activated by the normal routine, follow this emergency procedure:

- open the door with the key; the alarm will sound for 30s.
- enter the car, close the door and turn the ignition key to position 1. The alarm will sound again for 30s.
- Wait for the LED to go out (LED goes out after approx. 5 minutes, then wait a further 10 minutes). Do not open the door during this period, nor turn the ignition key away from position 1.

The system will then be de-activated. Have it checked by a BMW service station.

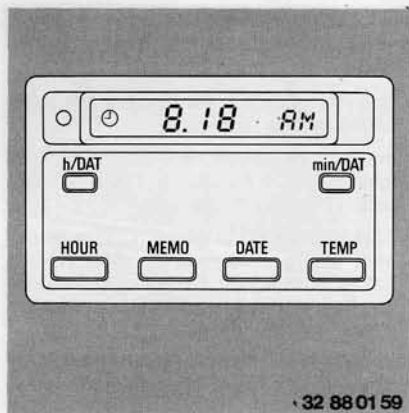

Outside temperature display and digital clock *

In addition to the actual time, the date and the outside temperature can be displayed and the MEMO key used to select an hourly reminder signal.

In ignition key position 0, time and date can be read off after pressing the appropriate function key. In ignition key position 1 and beyond, the time is displayed. Numerical values can be input or modified.

Time and date inputs

After the power supply has been interrupted (initial input, flashing dot), the time can be input without first pressing the function key (HOUR-DATE) by way of the two input keys h/DAT and min/DAT. To input the date, the DATE function key must first be pressed.

Each time an input key is pressed or held in for half a second, the numerical value increases by one.

The clock function is shown by a symbol, the date function by the DATE display.

To start the clock to the nearest second, press the HOUR key. To start the calendar program, press the DATE key. The dot will then cease to flash.

Before any other input alterations, keep the appropriate function key (HOUR or DATE) pressed until a flashing dot appears between the hours and minutes or between the day and month.

If another function is selected after making an input, the previous input will remain valid.

The program does not accept unrealistic inputs. The date display disregards leap-years and must therefore be corrected manually.

Notes for 12-hour clock

The change from AM to PM takes place every 12 hours and is shown in front of the numerical value. To allow for various national versions of the digital clock and outside temperature display, the time and temperature functions can be reset as follows:

- 24 h and °C
- 12 h and °F or
- 12 h and °C

on the rear cover of the unit. When changing from 24h to 12h, the input keys automatically change their functions from day and month to month and day (US method of writing date).

Memo

The MEMO key is used to switch an hourly reminder signal on and off. The signal is heard 15s before each full hour, and is useful (for instance when listening to a tape cassette) when news broadcasts are due. The letters ME are displayed when the reminder is activated.

Outside temperature

By pressing the TEMP key, an outside temperature display can be obtained. If the outside temperature is below +3°C, an ice warning signal is heard if the ignition key is in position 1 and beyond. At the same time the temperature unit (°C/°F) and the dot in the display flash for 10 seconds.

If another function is selected during the period, and the temperature display selected again afterwards, only the visual warning signal is active for the remaining period.

The temperature warning is repeated if the temperature has risen to +6°C at least once before falling again below +3°C.

Do not rely exclusively on the low-temperature warning: ice can still form on bridges and patches of road in shade even at indicated temperatures above +3°C.



Time switch * for independent heater/ventilation system

This enables the independent heater/ventilation system to be switched on and off directly, and a switch-on time between 0.00 and 23.59 to be preselected.

Direct switch-on: press the ON key for 3 seconds, until the LED flashes.

Switching off: press the OFF key.

Switch-on time input:

The ignition key must be in position 1 or beyond, and the HOUR function must have been selected.

Every time the TIMER key is pressed, a fan symbol appears on the digital display and alternately 1 and 2 to indicate the selected and input switch-on time.

Once the desired figure has been selected, the appropriate switch-on time can be input.

Press the TIMER key until the dot between the hours and minutes display begins to flash.

Input the desired switch-on time with the h-DAT and min-DAT keys.

Press the TIMER key again: the dot will stop flashing. The switch-on time is then programmed.

Activating the programmed switch-on time (ignition key in position 1 or beyond): after selecting the switch-on time, press the SET-RES key. The LED comes on until the time for the independent heater/ventilation system to start automatically is reached.

The LED above the ON key then confirms that the system is in operation.

De-activating the switch-on time: after selecting the switch-on time, press the SET-RES key again. The LED will go out.

Once programmed, a switch-on time can be activated and de-activated with the SET-RES key as often as required. It remains programmed until a new time input is made.

If the car is equipped with an **on-board computer, the system is operated with the TIMER and S/R keys.**

Independent heater * /ventilation system*

Below an outside temperature of 16°C, the **independent heater** is ready to operate when the ignition key is removed (or in position 0) and also in ignition key position 1.

With the aid of the preselected switch-on time, the interior of the car is always warm when you wish to start your journey and in cold weather it is easier to remove snow and ice from the vehicle.

The independent heater and the independent ventilation control system both operate for a 30-minute period. Since power consumption is high, the independent heater should not be run twice in close succession unless the battery has been recharged in the meantime by driving the car for a period at reasonable speeds.

The heated air automatically emerges through the defroster and footwell outlets at the front and rear, at maximum output. The interior temperature can only be preselected at the rotary controls or selector wheels and the airflow regulated individually with the pushbuttons when the ignition key is in position 1.

Note: after switching off (LED goes out), the independent heater continues to run for a short time.

Above an outside temperature of 16°C, the **independent ventilation system** can be run to ventilate the car's interior and lower its temperature (ignition key position as for independent heater). The ventilation is controlled via the blower for the heating or automatic air conditioning system.

Air automatically emerges through the controlled-flow, directional grilles on the fascia. For efficient operation of the independent ventilation system, these grilles must therefore be fully open.

Important notes

If the independent fuel-burning heater does not start after not more than **two attempts**, or switches itself off automatically, consult a BMW service station.

Never run the independent heater in an enclosed space.

Always switch off the independent heater before adding fuel to the tank.

Recommendation: operate the independent heater briefly about once a month during the warm period of the year (approx. 5 mins).

At temperatures above 16°C, proceed as follows:

Time switch: press the TEMP key for 3 seconds; the letter E will appear.

On-board computer: press the TEMP and TIMER keys at the same time for approx. 3 seconds; the IN display will appear.

After this, the independent heater can be operated once (switch on and off directly).

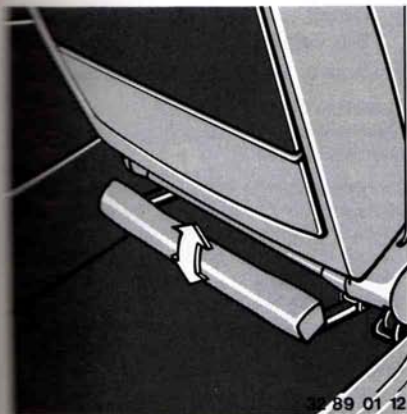

High-Line rear seat area specification *

Footrests

Fold up when not in use.

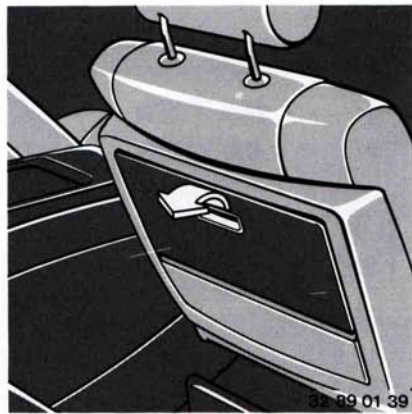

Folding tables

When folded down, the indirect lighting comes on.

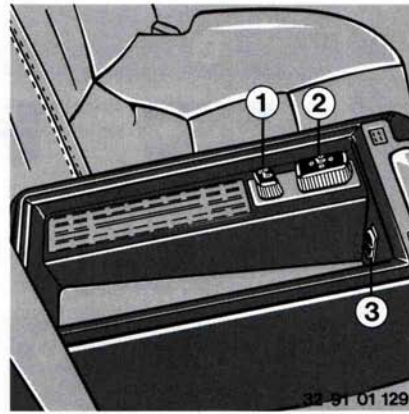

Front-passenger seat adjustment

Fold out the centre armrest and open the lid.

By adjusting the seat back and head restraint (switch 1) and the seat base (switch 2), the footrest and folding table can be adjusted according to individual preferences, and adequate vision assured.

Electric rear window roller blind

Touch rocker switch 3 to operate.

The roller blind can also be operated from the front seats.
See Page 57.

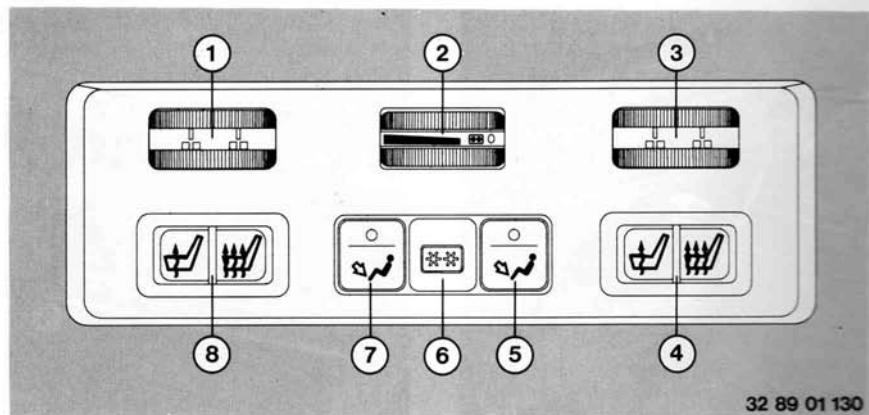

32 89 01 130

Individual air conditioning system for rear

- 1 – Temperature selector wheel, left side
- 2 – On/off and selector wheel for coolbox control and airflow
- 3 – Temperature selector wheel, right side
- 4 – Rocker switch for seat heating, right side
- 5 – Pushbutton for lower airflow, right side
- 6 – Telltale for coolbox operation
- 7 – Pushbutton for lower airflow, left side
- 8 – Rocker switch for seat heating, left side

The system operates independently of the automatic air conditioning system. It also permits individual selection of temperatures on either side at the rear, together with temperature stratification for fatigue-free travel: feet warm, head cool.

1, 3 – Rotary temperature selectors for left/right side

Turned to the right: air temperature increases.

The selected temperature is reached as soon as possible after the car has been started.

2 – On/off and selector wheel for coolbox control and airflow

Position 0: system off, airflow closed.

Turned to position  (detent/telltale lamp 6 on):
Only coolbox on.

Turned further to right: system comes on, airflow volume increases. The air emerges through the footwell outlets (opened and closed at pushbuttons 5 and 7) and through the directionally controllable, variable-flow grilles above the controls.

The air conditioning system remains switched on at low outside temperatures to keep the air emerging through the grilles at an agreeable temperature and for coolbox operation.

5, 7 – Pushbutton for lower airflow right/left

When depressed (LED comes on), the footwell outlets are open.

6 – Telltale lamp for coolbox operation

Comes on when coolbox is operating.

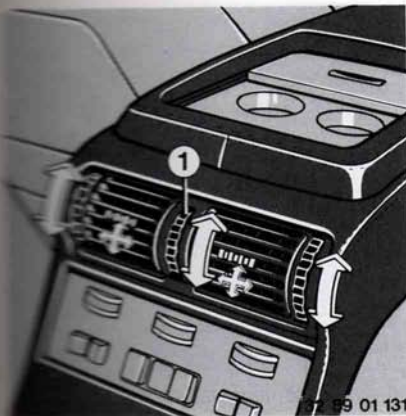

Stratified temperatures for freedom from fatigue on long journeys: feet warm, head cool

Knurled wheel 1 varies the temperature of the air emerging from the grilles (except at maximum ventilation output)

Up: warmer

Down: cooler

and also opens the footwell outlets.



Coolbox

Coolbox operation: see previous page, selector wheel 2.

Cleaning the coolbox: clean only with a soft cloth and lukewarm water, to which washing-up liquid may be added. Dry using a soft cloth.

Warning:

Do not remove the coolbox insert or block the air inlets.

Electric rear-seat heating

The seat cushion and back can be heated when the ignition key is in position 2.

Press rocker switches (4 and 8) on the control panel for the rear air-conditioning system:

- ⋮ Rapid heating while the symbol is illuminated. Automatic changeover to regular heating.
- } Regular heating. Cuts out automatically when the switch is no longer illuminated.

To switch over while heating: press the non-illuminated switch symbol.

To switch off prematurely: press the illuminated section of the switch.

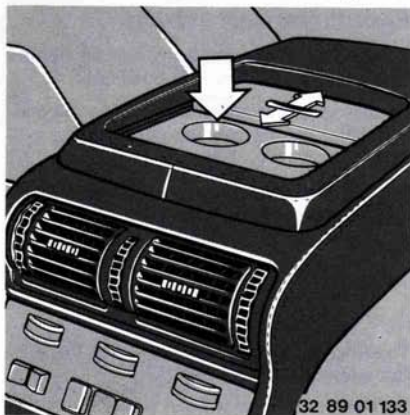

Drinks tray

Push cover forwards.

The recesses in the tray are designed to match the glasses in the holders inside the coolbox.

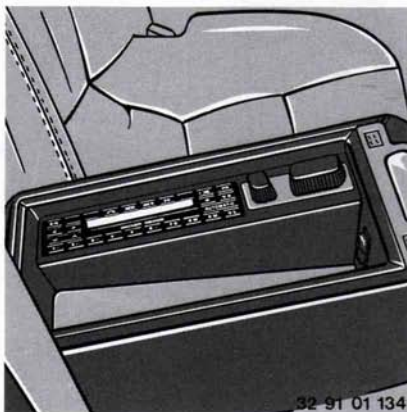

Remote control of radio

The layout and function of the remote-control radio buttons on the centre armrest correspond to those on the fascia set.

See the radio operating instructions.

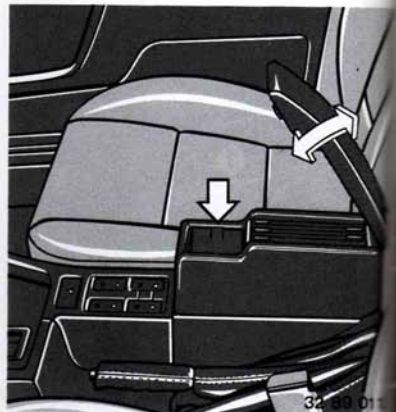

CD holder

Open the lid and press the button for desired compartment.

Spectacles compartment

To remove the insert, press tab (arrow).

If a car telephone is fitted, the CD holder located in the glove box.

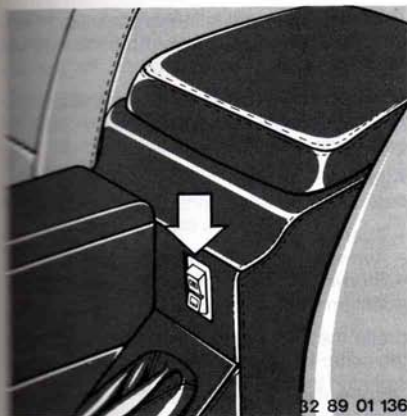

Electric roller sun blind for rear window

The rocker switch is located behind the handbrake, as illustrated.

See also Page 45.

The roller blind can also be operated from the rear seats. See Page 53.

Real wood trims and parts in real wood

Clean only with a damp cloth, then use a soft cloth to dry.

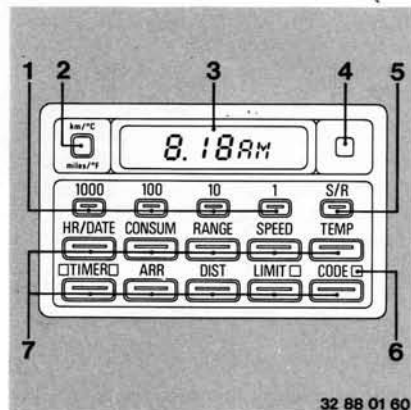

On-board computer *

- 1 – Input keys for numerical data
- 2 – Unit of measurement changeover
- 3 – Digital display
- 4 – Photo-transistor for automatic control of display brightness
- 5 – Start-stop (SET/RESET) key
- 6 – Light-emitting diodes (LEDs)
- 7 – Information keys

The on-board computer can supply the following information outputs for safe and economical driving:

- HR/DATE – Time and date
- CONSUM – 2 average fuel consumption readings
- RANGE – Range on remaining fuel
- SPEED – Average speed
- TEMP – Outside temperature
- TIMER – Stopwatch and 2 switch-on times for independent fuel-burning heater/ventilation system
- ARR – Estimated time of arrival
- DIST – Distance from destination
- LIMIT – Speed limit warning
- CODE – Immobilisation of car

The computer is ready for use at ignition key position 1 and beyond.

For road-safety reasons, always **input information before commencing a journey**, or with the car at a standstill.

Press the appropriate information key to obtain the following displays (no other input is necessary):

- Average fuel consumptions 1 and 2
- Range on remaining fuel
- Outside temperature

After pressing one of the information buttons:

- Average speed
- Average fuel consumptions 1 and 2
- Stopwatch (with independent heater/ventilation if installed)

press the S/R button (5) to restart or stop the computer, and call up or erase an hourly signal in the HOUR function.

Numerical inputs for:

- Time/date
- Speed limit warning
- Switch-on times 1 and 2 for independent fuel-burning heater/ventilation
- Distance from destination (used to estimate the time of arrival)
- Immobilisation of car

are described on the following pages.

After selecting the appropriate information key, the unit of measurement changeover key (2) can be used to display any individual item of information (not applicable to CODE) in either metric or Imperial units.

If the power supply to the on-board computer is interrupted, e. g. when changing the battery, all stored data are erased.

Once the power supply is reconnected, the required information data (time, date, speed limit warning, distance and switch-on times (if required)) must be input again.

Contact a BMW service station if the fault display PPPP should appear.

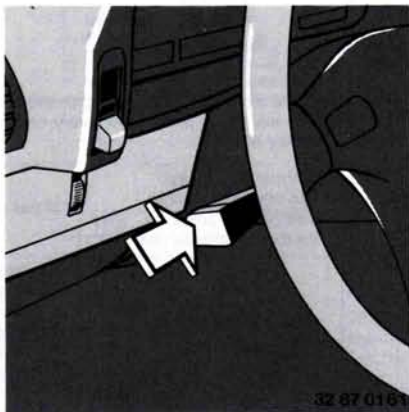

Remote control of on-board computer

If the turn indicator lever is pushed in briefly: Information is displayed additionally on the instrument panel strip: items can be called up in succession. The on-board computer display remains unchanged when other items are shown on the instrument panel.

To erase the display on the instrument panel, press the Check Control button on the panel or, with the ignition switched on, the CODE key.

Note: the display of Check Control warnings takes priority over information from the on-board computer.

If you wish to have all the information available for display on the instrument panel, proceed as follows:

- Press the turn indicator lever in for 3 seconds; the PROG 1 display will appear (P 1 on the on-board computer).
- Press the S/R key.

If only a limited amount of information is required on the instrument panel display, proceed as follows:

- Press the turn indicator lever in for 3 seconds, until the PROG 1 display appears (on the on-board computer: P 1).
- Press the desired information keys.

Note: for average fuel consumptions 1 and 2, switch-on times 1 and 2 for independent heating/ventilation and the date, the following should be taken into account: if both fuel consumption values are displayed, for instance, the CONSUM key must be pressed twice. If only average fuel consumption 2 but not average fuel consumption 1 is required, press the units of measurement key after the CONSUM key. Each time the changeover key is pressed again, fuel consumption readings 1 and 2 will alternate.

The same procedure applies to switch-on times 1 and 2 and the date.

- Press the S/R key.

Computer data input and information displays

Important: use decimal input sequence for numbers:

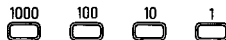























The memory will not accept illogical inputs.

























When a number is input, the number stored in the memory is erased; digits can be altered individually in any order.

To input to memory: press the S/R key.

The appropriate numerical display increases by one each time the key is pressed or every half a second if the key is held in.

	Input: press keys in the sequence illustrated	Information display: if an unwanted output is displayed, press approp. information key	Notes on input and information display
Time (Date)			<p>If display is ---- AM (after power failure), input time again. Clock can be started after input to the nearest second by pressing the S/R key (e. g. when a radio time signal is heard). Date input as for time. After pressing the S/R key the year is displayed. Input the correct year if necessary and press the S/R key again.</p> <p>To obtain date display from other information: press HR/DATE key twice.</p> <p>To adjust the time or date display, input the required figures while the display is visible, then press S/R.</p> <p>Hourly signal: in HOUR function, press S/R key; a sound symbol is displayed. Three pips are heard just before each hour. The time is displayed briefly on the instrument panel strip.</p> <p>To switch off reminder signal: in the HOUR function, press S/R again. To obtain time and date display in ignition key position 0: press the HR/DATE key.</p>
Average consumptions 1 and 2			<p>Recalculated since start of journey when S/R key is pressed. Repeated use of the CONSUM key selects average consumption values 1 and 2 alternately; an indication of which value has been selected appears on the digital display for a short time.</p>
Range			<p>Plus sign (+) in front of display indicates "full tank".</p>

	Input: press keys in the sequence illustrated	Information display: if an unwanted output is displayed, press approp. information key	Notes on input and information display
Average speed	SPEED  S/R 	SPEED 	Recalculated from start of journey when S/R key is pressed.
Outside temperature	-	TEMP 	Automatic temperature display below +3° C (37.5° F). Gong sounds and unit of measurement flashes for 8 seconds. The temperature value is displayed briefly on the instrument panel strip.
Stopwatch - Start	 → 	-	There is no stopwatch function in cars with an independent fuel-burning heater/ventilation system. When the stopwatch function is running, the LED lights up.
- Intermediate time	-		LED flashes, stopwatch continues to run. Press the TIMER key again: the running stopwatch display will reappear.
- Stop	 → 	-	To stop the stopwatch when another display is shown. Otherwise, simply press S/R. Press S/R again to restart the stopwatch.
Independent heater/ ventilation system - Direct switch-on	 → 	-	When the TIMER key is pressed, the current inputs to the independent heater/ventilation system are displayed. Direct heater operation in ignition key position 1. Switching off also possible in key position 0. In the TIMER function, press S/R key only.
- Direct switch-off	 → 	-	
- Preselecting switch-on times 1 and 2	      S/R 	 	Input is possible only when the clock is in operation. With the TIMER function selected, press the key once only; for switch-on time 2, press it again (confirmed on display). When the LED comes on, the heater/ventilation system will run for 30 minutes from the selected switch-on time. During the actual period of operation, the LED flashes. It goes out when the system is switched off. To correct the switch-on time, follow the same procedure as for initial inputs. After selecting the switch-on time 1 or 2, activate or de-activate the timer by pressing the S/R key. When activated, the appropriate LED comes on.

	Input: press keys in the sequence illustrated	Information display: if an unwanted output is displayed, press approp. information key	Notes on input and information display
Distance to destination	· DIST      S/R 	DIST 	If the preset distance is exceeded, the additional distance is still counted, but preceded by a minus sign.
Estimated time of arrival	-	ARR 	The probable arrival time on the basis of the distance input is continuously recalculated according to driving style at any given moment. This information is only available after a distance has previously been input. If the distance has already been completed, the DIST function appears instead of the ARR function. If selected from another function, - - - - ARR ist displayed.
Speed limit warning	LIMIT <input type="checkbox"/>     S/R 	LIMIT <input type="checkbox"/> 	If the input speed limit is exceeded, the LED flashes and a gong sounds. The limit value appears briefly on the instrument panel display. Press the information key again to switch off the speed limit warning: the LED will go out, but the speed value in the memory is retained. To store the speed at any given moment in the memory: in the LIMIT function, press the S/R key.
Code to immobilise car - to activate	Ignition key in position 1 CODE <input type="checkbox"/>      S/R 	-	Code numbers from 0000 to 9999 can be input. Important: memorise the code number! Ignition key turned to 0: LED comes on for up to 36 hours.
- to deactivate	Ignition key at 1 or 2     (Input code) S/R  or start engine	-	Warning: if 3 incorrect inputs are made consecutively, or 3 attempts are made to start the engine, an alarm sounds for 30 seconds.

Further information on the on-board computer

Changes in information programs are only possible after pressing the relevant information key.)

TIME/DATE



The time and date are displayed alternately by pressing the key. The date display disregards leap years and must be corrected manually as appropriate.

FUEL CONSUMPTION



By giving the instruction to restart calculation at a carefully selected moment, average consumption for the entire journey and for part of the journey can for instance be calculated at the same time.

RANGE



By pressing this key, the estimated distance which can still be covered with the fuel remaining in the tank is computed continuously according to driving style and display when selected. Below a range of 15 km (9.3 miles), a flashing four-segment display indicates that more fuel is urgently required.

The on-board computer only registers the position of fuel in ignition key positions 1 and 0, and when at least 5 litres of fuel are added. A plus sign (+) before the display indicates that the car has a greater range than indicated, as a result of limits in recording fuel level in the tank.

TEMP



The warning gong sounds again if the temperature has increased to +6°C (43°F) at least once since the last warning signal, then dropped below +3°C (37.5°F) again. Note that the absence of a low-temperature warning does not mean that ice may not have formed at a temperature above +3°C (37.5°F), for example on bridges or in shadow.

TIMER



Stopwatch: The maximum time which can be measured is 99 hours 59 minutes. The time display shows seconds and tenths of a second for the first minute, then minutes and seconds, and hours and minutes after the first hour. The stopwatch is halted when the ignition key is turned to position 0, and restarts when it is turned to position 1 or beyond.

Independent heater/ventilation system: If the key is pressed again when other information is being displayed, the following information can be obtained in succession: current situation, switch-on time 1, switch-on time 2, current situation again etc.

LIMIT



A new speed limit value can be input or displayed. The gong will sound again if the car has slowed down by 5 km/h or more at least once since the gong first sounded and then been accelerated up to the input speed limit again.

CODE

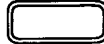

When the system has been activated, the engine compartment lid, radio and any attempts to start the engine are monitored.

If the engine compartment is not properly closed or the radio is removed, the LED flashes for 10 seconds when the ignition key is turned to 0.

If the ignition key is turned to 1 or 2 with the system activated, the gong will sound and a ----display will appear. This requires the code to be input. If the engine is started without a code input having been made, the warning gong sounds continuously.

Emergency starting procedure if the code has been forgotten:

- Disconnect and (after app. 5 minutes) reconnect the battery (see Page 86), the alarm will sound.
- Turn the ignition key to position 1
- A time display will appear and run down to zero for 15 minutes.
- After 15 minutes, the engine can be started.

If the code is remembered again, it can be entered during the waiting period of 15 minutes:

- Press the CODE key
- Input the desired code
- Press the S/R key
- Start the engine.

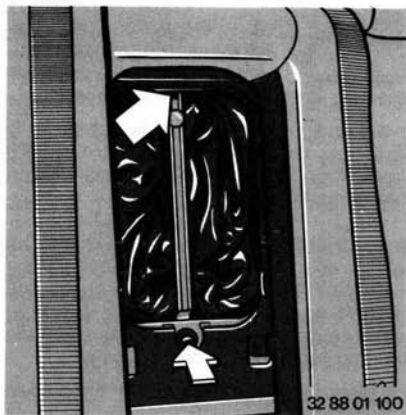

32 88 01 100

Ski bag *

The ski bag is a safe, clean method of carrying 3 to 4 (max.) pairs of skis.

The ski bag is 1.20 m long. Together with the space represented by the length of the luggage compartment, skis up to 2.10 m long can be carried. Note that if several pairs of skis are carried in the bag, the available space inside is reduced where the bag becomes narrower, so that only 2 pairs with the maximum length of 2.10 m can be carried.

Loading the ski bag

After the centre armrest of the rear seat has been hinged out, the trim can be detached at the upper burr fastener and placed on the armrest.

To release the loading flap in the luggage compartment, press the round knob, then disconnect the retaining loop at the upper hook and lower it.

Spread the ski bag out between the front seats.

A zip fastener is fitted for ease of access to the stored objects and to allow any moisture in the ski bag to dry out more effectively.

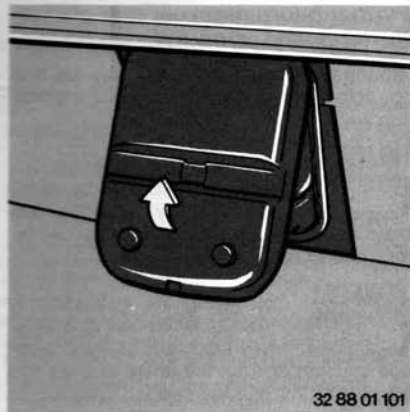

32 88 01 101

Secure the loading flap from the luggage compartment side against the underside of the rear-window shelf, using the magnetic retainer.

Make sure that the skis are clean before they are inserted into the bag, and that there are no sharp edges which could damage it.

The material from which it is made is water-proof, and melted ice or moisture condensate should therefore be wiped off after use.

If the ski bag is not used for a lengthy period, make sure that it is stored in a dry condition.

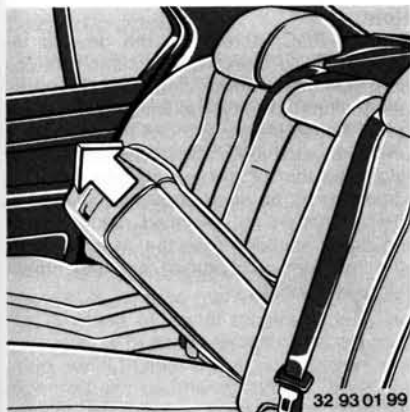

If more space is required, the centre armrest can be removed:

Fold out the armrest half-way, remove the trim at the top at the bur fastener and lay it down to the front. Hold the front of the armrest with one hand, reach behind the armrest with the other hand and tug upwards in a forward direction to remove.

Installation:

Introduce the armrest into the holders on both sides in the same position as for removal and press down with a jolt to engage.

Caution:

When removing and installing, take care that the pins on either side do not damage the seat upholstery.

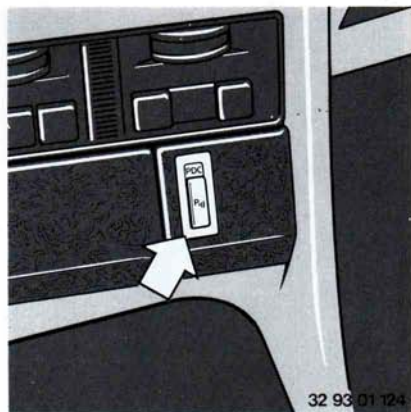

32 93 01 124

Park Distance Control (PDC) *

When activated, four ultrasonic sensors in the front and four in the rear bumper measure the distance from the nearest object and indicate it by means of an audible signal.

The measuring zone for the four front sensors and the two rear corner sensors starts app. 20 cm ahead of the bumper and extends for about another 40 cm. The width of the measuring zone for the two central rear sensors is 1.30 m. The front distance signal is high-pitched, the rear signal lower in pitch. The system is controlled by the reverse gear contact switch and the speedometer distance signal.

As the car approaches the external obstruction, the warning signal sounds at more frequent intervals, changing to a continuous tone if the object is less than 20 cm away.

The system is **activated automatically** in ignition key position 2 when reverse is selected at the manual gearbox or automatic transmission.

It can be **switched on and off manually** at the pushbutton (arrow) on the centre console (telltale light comes on or goes off as appropriate).

If the car is driven for more than app. 50 metres or reaches a speed of app. 30 km/h, the system is shut down and has to be re-activated when required.

If the car does not approach an obstruction identified by the corner sensors more closely, for example if it is driven parallel to a wall, the warning signal is interrupted after three seconds.

Any malfunction is indicated by a short continuous tone and by the telltale light flashing (if the system was activated by selecting reverse, by the flashing telltale light only). Switch the system off in this case and have the cause of the malfunction traced and rectified by a BMW service station.

Note:

Despite PDC, it remains the driver's responsibility to detect obstructions and ensure that the car keeps clear of them, particularly since the physical limits of the ultrasonic measuring system can be reached at any time, such as towing hitches and couplings and thin or painted objects, and obstructions in the dead area not covered by the sensors are not identified, nor is a warning signal emitted. Keep the sensors clean and free from ice to ensure that they remain fully operational.

Car radio operation*

The strength of the signal received by your car radio aerial, and thus the quality of sound emerging from the loudspeakers, depend on the position of the receiver and the height and directional location of the aerial.

These factors are relatively easy to take into account on a domestic radio set, but for a mobile radio such as that in a car, certain concessions have to be made. The position of the radio is constantly changing, and it is impossible to keep the aerial aligned with the direction of signal transmission. (The rear window heating elements also act as a radio aerial.) Other disturbance factors are high-tension overhead wires, poor or missing interference suppression on other vehicles, buildings and natural obstacles. Even if your car radio is perfectly tuned and your car is equipped with proper interference suppression, unavoidable noises and loss of high-quality sound can be quite severe.

Climatic effects such as fog, rain and snow can interfere with good radio reception.

As the **strength of sunlight** increases, long, medium and short wave reception is adversely affected. These wavebands can be heard best after dark, when the ionosphere reflects more of the transmitted signals back to earth.

The medium (MW), long (LW) and short (SW) wavebands provide a more extensive or, in some cases, exceptionally wide reception range, since the signals are dispersed not only as **ground waves**, but also as **space waves**, which are reflected back to earth by the ionosphere.

There are physical reasons why the quality of **medium wave** reception is not as good as on FM. Long-distance reception, however, is quite acceptable, particularly at night, so that a large number of stations can be picked up. However, station density is such that mutual interference often occurs.

Sound reproduction on the medium waveband seems rather dull in quality by comparison with FM.

On the **long waveband**, transmitters still farther away than on medium wave can be picked up.

Short wave offers the longest theoretical reception distance. Maximum station density and, subject to basic physical limitations, best sound quality, are obtained in the 49-metre band.

The **very-high frequency** transmission system uses the frequency modulation (FM) principle and offers far better sound quality than the other wavebands. However, reception is limited to only a few stations within any area, since the radio waves are emitted **in a straight line** from the transmitter tower, and therefore cover an area not more than app. 80 km in radius. As the distance between the transmitter and receiver increases, background noise becomes more of a problem, and finally the station can no longer be heard or is displaced by a more powerful one which the car is approaching. This situation can only be avoided by retuning to a stronger signal; something that has to be done relatively frequently when listening to FM transmissions.

Stereo transmissions, if available in your area, can normally be received on FM only. As you move away from the transmitter, interference becomes noticeable more rapidly than on mono transmissions. In this case, switch to mono reception or retune to a station providing a more reliable stereo signal.

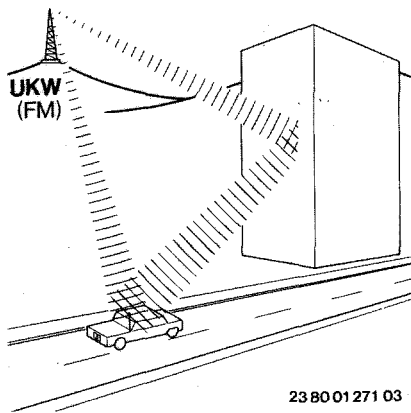

Hissing, sizzling and splashing noises occur when reflected signals are picked up by the aerial a fraction of a second after the main signals, from large buildings nearby for example. The sound level also fluctuates repeatedly as a result.

Continuous background noise normally indicates that the edge of the transmission zone has been reached, or that the car has been driven into a "shadow", where no direct signals can be received. The only remedy is to tune to a nearer or more powerful transmitter.

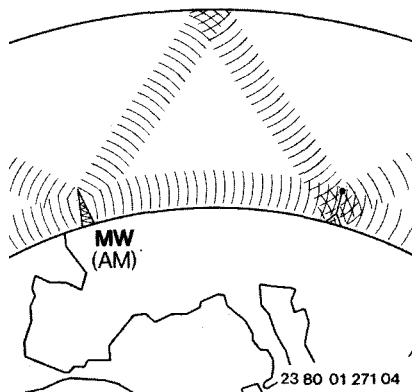

Severe fade is a phenomenon more often encountered on medium wave and usually accompanied by distortion. It is caused by the superimposition of ground and space waves at the reception point.

Fluttering noise is caused by signal fade, when the line of sight between the transmitter and receiver is blocked by large buildings or topographical features. A similar effect is sometimes heard when driving along tree-lined roads.

Car telephone *

If a car telephone system is installed subsequently, it may be necessary to fit a second battery of appropriate capacity in accordance with BMW guidelines, with an isolating relay to separate it from the vehicle's power circuit. Your BMW service station will be pleased to advise you.

Note:

Mobile communication systems (car telephones, two-way radio etc.) can cause interference if they are not approved for use in your car. Since BMW cannot examine and test each product, it is unable to accept any responsibility for the installation of items it has not approved. Before purchasing any such equipment you are recommended to consult your BMW service station.

Furthermore, in order to safeguard your BMW's operating reliability, do not operate any in-car telephones or other mobile radio equipment with an aerial **inside** the car.

Starting the engine

- Apply the handbrake.
- Move the gear lever to neutral (the automatic transmission selector lever to P or N).
- In particular at low outside temperatures, switch off all electric power consumers and fully depress the clutch pedal.
- **DO NOT DEPRESS THE ACCELERATOR PEDAL WHEN STARTING THE ENGINE.**

However, if the engine does not start at the first attempt, e.g. in very cold or hot conditions, press the accelerator pedal half-down when trying again.

Additional notes

Run the starter long enough for the engine to start, but no longer than 20 seconds without a break. Release the ignition key as soon as the engine starts.

Starter motor repeat lock:

Before repeating an attempt to start the engine, turn the ignition key back from 1 to 0. This is to prevent re-engagement of the starter pinion while the engine is still turning.

Avoid repeated starting attempts at short intervals, or else the spark plugs will become wet.

In severe frost:

Observe a 20- to 30-second pause between attempts to start the engine in order to protect the battery.

The engine is automatically controlled to run at an idle speed appropriate to the operating conditions in each case.

Do not allow the engine to reach its normal operating temperature with the car standing still, but drive off straight away at a moderate engine speed.

Switching off the engine

Turn the ignition key to position 1 or 0.

Energy-conscious driving:

Fuel consumption is influenced above all by **driving style**.

- Do not warm the engine up to operating temperature at idle speed and never allow the engine to idle for long periods.
- Do not run the engine up to maximum speed in 1st gear; use it for pulling away only.
- Shift up to a higher gear in good time and make full use of the higher and more economical 3rd, 4th or 5th gears.
- Avoid driving for long periods at full throttle.
- Do not carry any unnecessary weight.
- Comply with the recommended tyre pressures.

Furthermore:

Energy-conscious driving reduces exhaust and noise levels.

Warning:

The car should never be left unattended with the engine running; this constitutes a very serious potential hazard.

Catalyst models

The catalytic converter fitted in the exhaust system reduces the exhaust emissions in the exhaust gas. These cars may **only** run on **unleaded fuel**.

Even minute amounts of lead in the fuel will cause irreparable damage to the lambda probe and catalytic converter.

The following points must be observed if the engine is to remain fully functional and free from damage:

- Always have the prescribed maintenance work carried out.
- Never run the fuel tank completely empty.
- If the engine misfires, switch it off immediately.
- Only tow-start when the engine is cold, as otherwise unburned fuel will reach the catalytic converter. It is preferable to use jump leads to start the car.
- Avoid other situations in which unburned or incompletely burned fuel could reach the catalytic converter, e.g.: frequent, prolonged operation of the starter motor within a short period, or repeated unsuccessful starting attempts. (Stopping and restarting the engine when functioning properly will present no problems.)
Allowing the engine to run with the spark plug caps disconnected.

If unburned fuel reaches the catalytic converter as a result of misfiring or fuel-air mixture preparation malfunctions, overheating and damage may result.

Warning:

High temperatures build up at the catalytic converter (as on all cars with this form of exhaust emission control). Make sure that no easily combustible material (for example hay, leaves, grass etc.) comes into contact with the hot exhaust system when the car is driving, idling or parked. If this material were to ignite and cause a fire, very severe injuries or damage could result.

Do not remove the heat shields from the exhaust system, or apply underseal to them.

Engine refinement is influenced by the exhaust emissions purification technology, fuel consumption and the quality of the fuel used.

The modified operating conditions are largely taken into account by the electronic measuring and control functions and the high-quality design and workmanship of individual components, e. g. in individual features such as the electronic ignition and fuel injection system.

The car's altered engine and road behaviour, for instance when accelerating from a low speed, when the combustion process resumes after the cruise control has been in operation and when the engine is running at a low idle speed, reflect the compromise between the need for low fuel consumption, improved environmental acceptability and luxury driving; these differences constitute no cause for concern.

The Digital Motor Electronics system fitted for optimum engine operation causes a certain period of uneven running when this system has been disconnected from the power supply and reconnected again.

The engine will regain its customary refined running once it has passed through all adaptation phases at operating tempera-

Running in

Please observe the following notes in order to help your vehicle achieve maximum efficiency and a long operating life.

Engine and final drive

The first 1000 km (600 miles):

Drive at varying engine and road speeds. Do not exceed a road speed of 140 km/h (87 mile/h).

Do not depress the accelerator pedal to the full-throttle position or allow the kickdown to operate.

After the first 1000 km (600 miles), road and engine speeds can be increased gradually.

If either of these assemblies has to be renewed later in the car's life, the running-in procedure must be repeated.

During the running-in period, a degree of stiffness may be noticed at the gear lever, in the steering and other assemblies. This will disappear after a short while and should be regarded as part of the normal running-in process.

Tyres

The production methods used in the tyre industry result in brand-new tyres having less than their designed road-surface adhesion. For this reason, you are urged to drive with restraint for the first 300 km (app. 200 miles).

Brakes

As a means of achieving uniform wear patterns and a good friction coefficient on new brake linings, try to brake only at moderate rates of retardation during the first 500 km (app. 300 miles). Avoid repeated violent braking actions, especially at high speeds, and also prolonged severe loads, such as when descending lengthy mountain passes.

Brake linings and discs need the distance and treatment stated above to bed down properly and avoid premature wear.

The handbrake operates separately from the foot brake system, with its own drums, and therefore also has to be run in.

If the braking effect declines noticeably with time, the driver can repeat the bedding-down process provided due care is exercised:

If road surface, weather and traffic conditions permit (care must be taken not to obstruct other road-users), the desired effect can be achieved by applying the handbrake lightly at about 40 km/h (25 miles/h) until definite resistance is felt. Then pull up the lever to the next notch and drive the car about another 400 metres before releasing the handbrake completely.

Fuel consumption

The standard test method used to determine fuel consumption (DIN 70 030, Part 1) obtains values which are by no means identical with the car's average fuel consumption in everyday driving. After all, this depends on a variety of factors such as driving style, load, road conditions, traffic density and flow, weather, tyre pressures etc.

For fuel consumption according to DIN standard, see Page 120.

Additional practical tips

Do not allow the engine to warm up to operating temperature at idle speed.

At exceptionally low temperatures however, allow the engine to run for about half a minute at a fast idle to ensure that oil reaches all parts of the engine.

Never run a cold engine at high speed, as this will cause rapid wear and shorten its operating life.

When driving under load, accelerating or climbing hills, try to prevent engine speeds falling below 1500/min. Shift to a lower gear in good time, particularly on uphill gradients.

When declutching, press the clutch pedal down fully. During normal driving, do not rest the foot on the clutch pedal.

Warning:

Do not rest your foot on the brake pedal while driving the car. Even slight continuous pressure on the brake pedal can cause overheating, pad wear and possibly failure of the complete brake system.

Recommendations

After a lengthy period in heavy city traffic or in a slow-moving queue of vehicles, let the engine "breathe deeply" by driving for a few kilometres at engine speeds above 3000/min. This will disperse any soot deposits in the combustion chambers.

Warning:

When the car is driven on a wet or slushy surface, wedges of water can build up between the tyres and the road. This is known as aquaplaning, and can even lead to the tyre losing contact with the surface, so that the car cannot be steered or braked properly. Always reduce speed as a precaution on wet surfaces.

Always keep the luggage compartment lid closed when driving along to prevent dangerous exhaust fumes entering the car. If you have to drive with the luggage compartment lid open, when transporting a bulky load for example, you are advised to close all the windows and the sliding/tilt roof (if fitted) and to run the heating/ventilation blower at a medium to high setting.

Warning:

Do not leave any heavy or hard objects on the rear-window shelf, or else they could injure the car's occupants when the brakes are applied suddenly.

If you hang clothing from the hooks provided, make sure that the driver's view is not obstructed.

Do not hang very heavy articles from these hooks, in case they cause injury to the car's occupants when the brakes are applied.

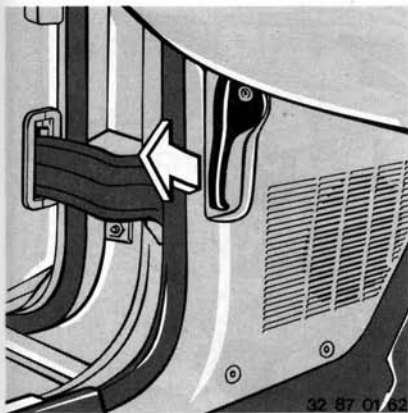

Engine compartment lid

To release: pull the lever on the left under the instrument panel.

Warning:

Stop the engine and allow it to cool down before carrying out any work inside the engine compartment.

The battery must be disconnected before performing any work on the car's electrical system and any other repair and maintenance work, particularly inside the engine compartment.

Careless handling of parts and materials when working on the car may involve personal risk. If you are unfamiliar with the regulations or instructions which must be complied with, have any such work performed by your BMW service station.

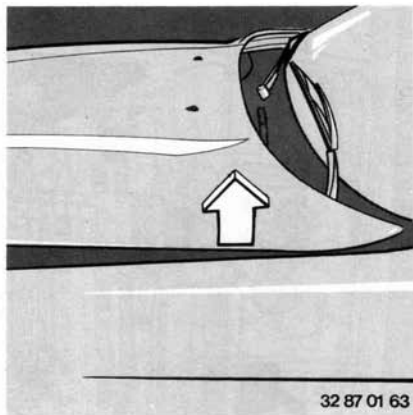

A built-in spring mechanism slides the lid forwards automatically to make it easy to open.

Engine compartment light

Comes on when the lid is opened, if the car's lights have been switched on.

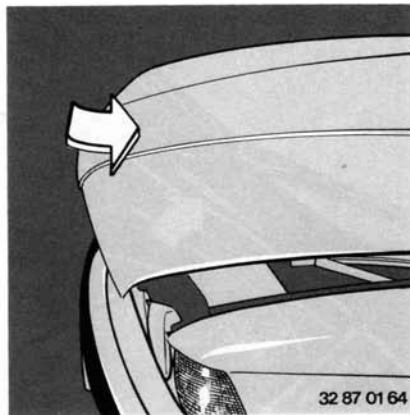

To close the lid, push the front evenly on both sides until it is heard to engage.

Raise slightly to ensure that the catches are holding the lid securely.

Warning:

If you notice that the engine compartment lid is not shut and held firmly in the closed position while you are driving the car, stop as soon as possible and close it correctly.

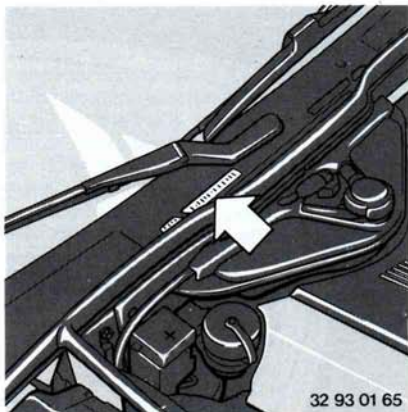

32 93 01 65

Vehicle identification number

In the engine compartment, next to the right windscreen wiper pivot (arrow), or on the left-hand side of the fascia at the top.

Maker's plate

In the engine compartment, ahead of the right wheel arch.

The information on the maker's plate and the vehicle identification number must comply with the data stated in the car's documents.

These data are used as a basis for all queries, checks and warranty and spare parts requirements.

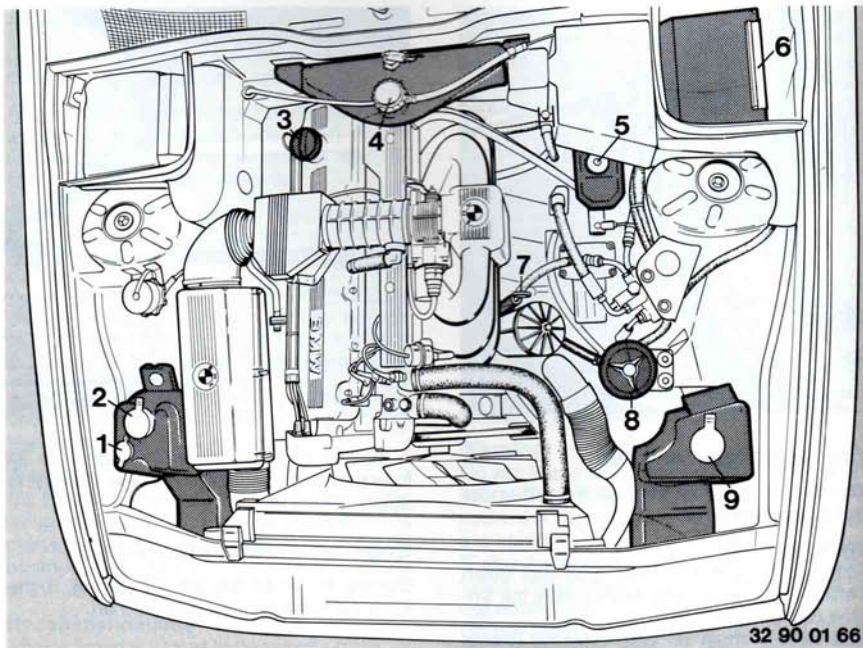

32 90 01 66

Principal items in the engine compartment – BMW 730i 6-cylinder

- | | |
|--|---|
| 1 – Intensive cleaning fluid reservoir | 7 – Engine oil dipstick |
| 2 – Windscreen washer fluid tank | 8 – Hydraulic fluid tank for power steering and self-levelling suspension |
| 3 – Engine oil filler | 9 – Headlight and fog light cleaning system fluid reservoir |
| 4 – Coolant equalizing tank | |
| 5 – Brake fluid reservoir | |
| 6 – Fuse box | |

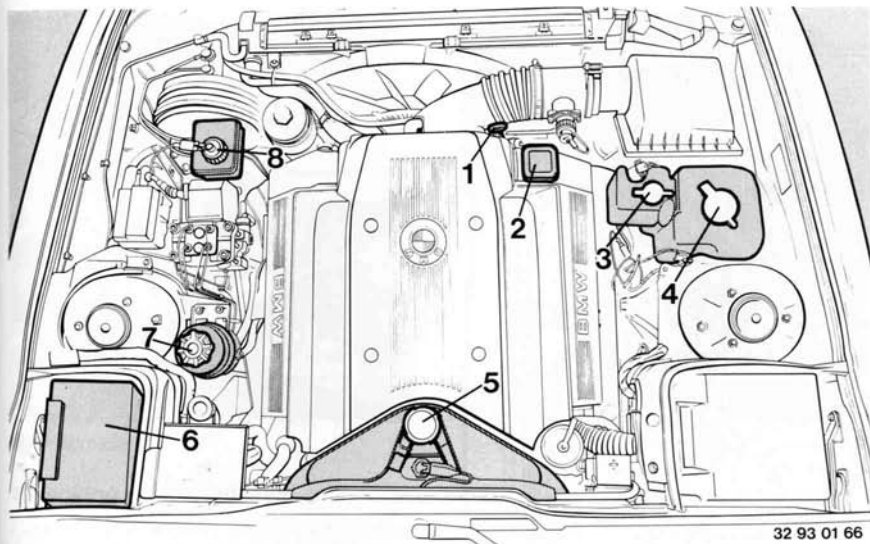

32 93 01 66

Principal items in the engine compartment – BMW 730i 8-cylinder, 740i/iL

- | | |
|--|---|
| 1 – Engine oil dipstick | 5 – Coolant equalizing tank |
| 2 – Engine oil filler | 6 – Fuse box |
| 3 – Reservoir for intensive windscreen cleaner | 7 – Hydraulic fluid tank for steering and self-levelling suspension |
| 4 – Reservoir for windscreen washer and headlight and fog light cleaning systems | 8 – Brake fluid reservoir |

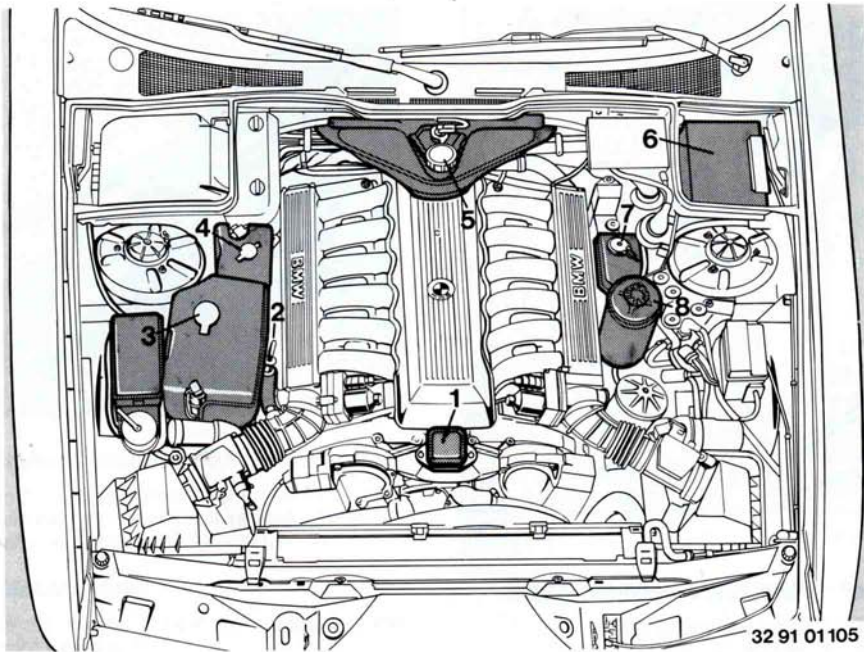

32 91 01105

Principal items in the engine compartment – BMW 750i/iL

- | | |
|---|---|
| 1 – Engine oil filler | 5 – Coolant equalizing tank |
| 2 – Engine oil dipstick | 6 – Fuse box |
| 3 – Reservoirs for windscreen washer and headlight and fog light cleaning systems | 7 – Brake fluid reservoir |
| 4 – Reservoir for intensive windscreen cleaner | 8 – Hydraulic fluid tank for brakes, power steering and self-levelling suspension |

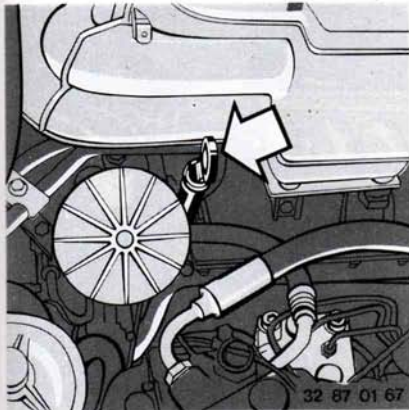

BMW 730i 6-cylinder



BMW 730i 8-cylinder, 740i/iL

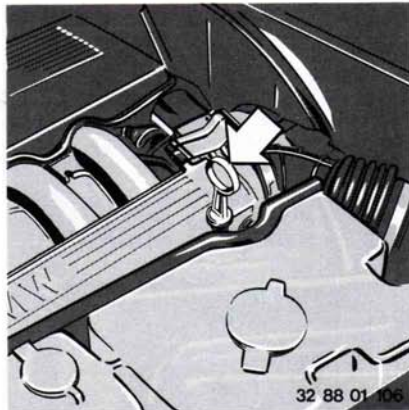

BMW 750i/iL

Checking engine oil level

Like fuel consumption, engine oil consumption depends on the way in which the car is driven and on operating conditions.

For this reason, the oil level should be checked regularly, e.g. every 1000 km (600 miles), or sooner if the engine has been driven hard. When checking, the car should be standing on a level surface.

For maximum accuracy:

Check the oil level before starting the engine, while it is cold. If the engine is warm, allow time for the oil to drain back into the sump (for instance, as long as it takes you to fill the fuel tank).

Insert the dipstick fully into its tube.

The oil level must be between the two marks on the dipstick.



BMW 730i 6-cylinder

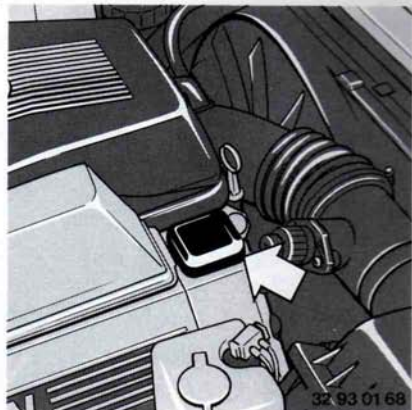

BMW 730i 8-cylinder, 740i/L

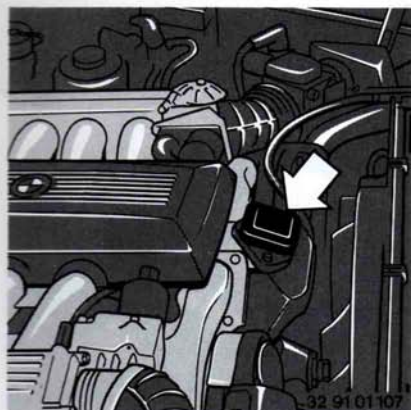

BMW 750i/L

Adding engine oil

If necessary, add engine oil at the filler. Do not fill above the maximum mark on the dipstick.

The quantity of oil represented by the space between the two marks on the dipstick is app. 1 litre (1.8 pints). Adding too much oil serves no useful purpose and harms the engine. Since excess oil is burned off rapidly, the engine would appear to be consuming excessive oil.

Do not add oil until the level has dropped to the lower mark on the dipstick. However, never allow the oil level to fall below this mark.

BMW engines are designed to operate without oil additives, provided that a highly-developed brand-name lubricating oil is used. Indeed, additives may actually lead to engine damage. The same applies to the manual gearbox, automatic transmission, final drive and power steering.

Engine oil specifications

The grades of engine oil to be used are exclusively governed by the CCMC or API specification.

Here are the required quality stages:

Preferred	Also permitted
CCMC-G4 CCMC-G5*	API SG
CCMC-G4/PD2 CCMC-G5/PD2*	API SG/CD API SG/CE

* If engine oils to CCMC-G5 or CCMC-G5/PD2 specification are to be used, BMW Service should be consulted regarding their suitability for use all the year round.

When disposing of old engine oil, comply with local environmental protection regulations.

A recommendation: always have oil changes carried out by a BMW service station.

The correct SAE viscosity grade to be used depends on outside temperatures, and therefore on the time of year.

The chart indicates the correct SAE grade of engine oil for various prevailing air temperatures.

Note that the temperature limits quoted may be departed from, but **only for brief periods.**

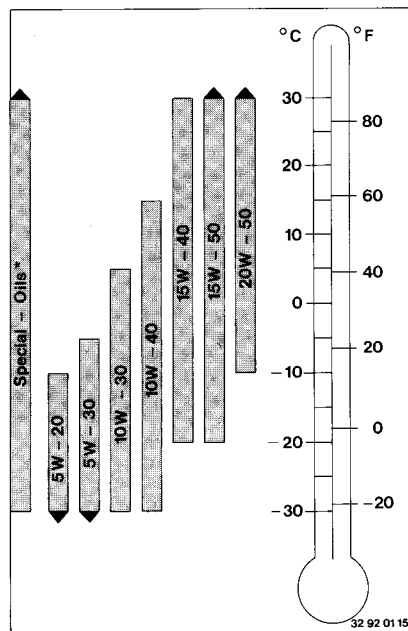

* Engine oils to CCMC-G5 or CCMC-G5/PD2 specification individually approved by BMW

Caution:

Continuous contact with used engine oil has caused cancer in laboratory tests. Wash skin thoroughly with soap and water after handling. Always keep oils, greases etc. out of reach of children! Please note precautions on containers.



Power steering – BMW 730i 6-cylinder

Steering hydraulics: checking oil level

With the engine at a standstill, unscrew the knurled nut and take off the reservoir cover.

The oil level must be between the two marks on the dipstick.

Top up oil if necessary. BMW service stations know the approved grades.

Allow the engine to run for a while. Top up the oil if necessary until the level is between the two marks.

Switch off the engine. The oil level may rise app. 5 mm (0.2 in) above the upper mark.

Screw the reservoir cap on tight.

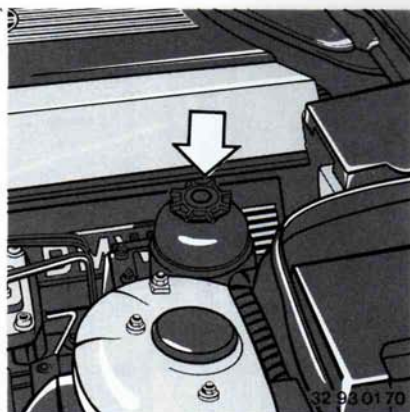

Power steering – BMW 730i 8-cylinder, 740i/iL

Power steering and self-levelling suspension *: checking oil level

With the engine at a standstill, unscrew the knurled nut and take off the reservoir cover.

The oil level must rise slightly above the base of the strainer (app. 5 mm or 0.2 in) with the car unladen.

Add fresh oil if necessary. Always use Pentosin CHF 11S or, if not available, LHM. If the vehicle is carrying a load, add 0.25 l Pentosin CHF 11S but stop adding if the oil level reaches the base of the strainer. Check the oil level again with the car unladen.

Fit the reservoir cap and tighten the knurled nut. Ensure that the cap is properly fitted.



Brake and steering hydraulics/self-levelling suspension – BMW 750i/iL

Oil tank for brake hydraulics, power steering * and self-levelling suspension *

If the announcement "P.A.S. FLUID" appears on the Check Control display, consult a BMW service station.

In an emergency, unscrew the knurled nut and take off the reservoir cover with the engine at a standstill and add 0.25 l Pentosin CHF 11S or, if not available, LHM. If the Check Control announcement remains on the display, add a further 0.25 l.

Fit the reservoir cap and tighten the knurled nut. Ensure that the cap is properly fitted.



BMW 730i 6-cylinder

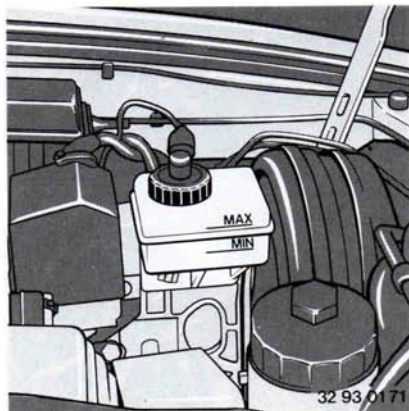

BMW 730i 8-cylinder, 740i iL



BMW 750i iL

Brake fluid reservoir

The oil level must be up to the top (MAX) mark. The cap need not be removed to check the level.

BMW service stations know the approved grades of brake fluid (DOT 4).

Warning:

Brake fluid is hygroscopic. That is to say, it gradually absorbs moisture from the atmosphere. To ensure that the brakes on your car remain fully operational, **have the brake fluid changed every 2 years** (BMW 750 i/iL: once a year) by a BMW service station.

See also note on Pages 86 and 99.

Brake fluid is toxic (poisonous) and also attacks the car's paintwork.

It must therefore always be kept tightly sealed in the original pack, and stored out of children's reach.

Comply with environmental protection laws when disposing of brake fluid or packs which have contained it.

Warning:

Do not spill brake fluid. Add it only up to the MAX mark on the reservoir. If brake fluid comes into contact with hot parts of the engine, it can ignite and cause serious burns.



Reservoir for hydraulic clutch fluid

BMW 730i 8-cylinder model only.

Add brake fluid as far as the upper mark.

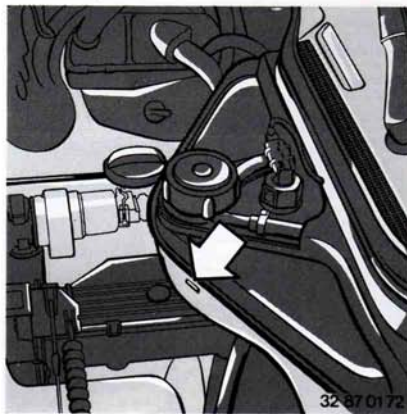

BMW 730i 6-cylinder

Checking coolant level

The level must be up to the MAX mark on the transparent equalizing tank.

Take off the cap only when the engine is cold (with the needle on the coolant gauge in the bottom one-third of the scale), **otherwise there is a risk of scalding.**

Turn the cap counter-clockwise slightly to allow excess pressure to escape before opening.

Overfilling causes coolant to escape via the overflow pipe.

Warning: never add water to the radiator while the engine is still hot.



BMW 730i 8-cylinder, 740i/L

The cooling system is designed for filling with a long-life antifreeze and corrosion inhibitor. No other additives should be used.

To avoid possible subsequent damage, use only factory-approved, nitrite- and amino-free long-life antifreeze and corrosion inhibitor. BMW service stations are familiar with the approved grades.

Warning:

Antifreeze is toxic (poisonous). Always keep it in the original pack or container, and out of reach of children.

Coolant **concentration:** see winter operation, Page 100.

Renew the coolant every 2 years.

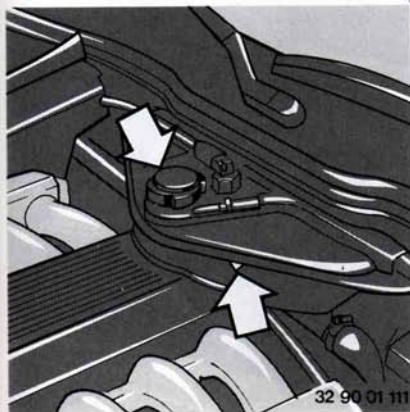

BMW 750i/L

Warning:
Long-life antifreeze and corrosion inhibitor contains flammable ethylene glycol, and must therefore not be spilled on hot parts of the engine, or else it could catch fire and cause severe burns.

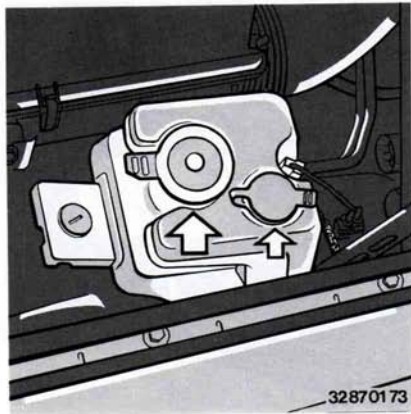

**Windscreen and intensive cleaning system reservoirs* –
BMW 730i 6-cylinder**

Windscreen washer system: capacity app. 3.0 litres (5.3 pints).

Top up with water and, when necessary and in particular at low outside temperatures, antifreeze in accordance with the manufacturer's instructions.

Intensive cleaning system: capacity app. 1 litre (1.8 pints).

Top up with intensive cleaning fluid (frost protection down to -27°C ; available from BMW service stations).

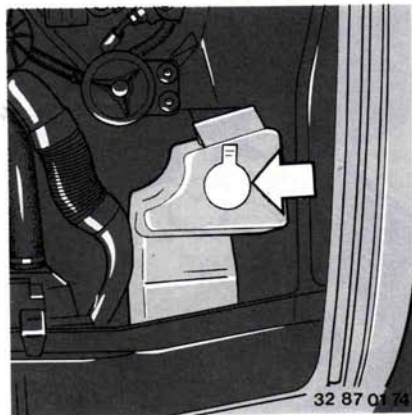

**Reservoir for headlight and fog light cleaning system* –
BMW 730i 6-cylinder**

Capacity: approx. 8.0 l (14.1 pints).
Fill in the same way as the windscreen washer fluid reservoir.

Warning:
Do not operate the automatic cleaning systems when the reservoirs are empty.

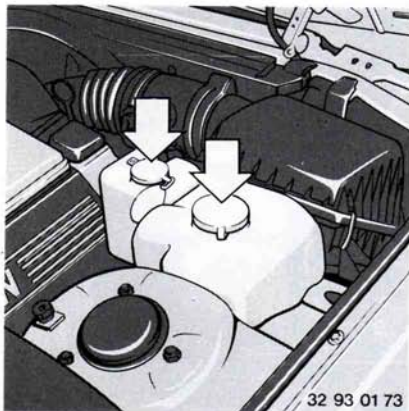

Reservoir for windshield washer, headlight and fog light cleaning systems and for intensive cleaning system – BMW 730i 8-cylinder, 740i/iL

Capacity approx. 7.5 l (13.2 pints); without headlight and fog light cleaning system approx. 2.5 l (4.4 pints).

Filling: as described above.

Intensive cleaning system: capacity approx. 1 l (1.8 pints).

Filling: as described above.

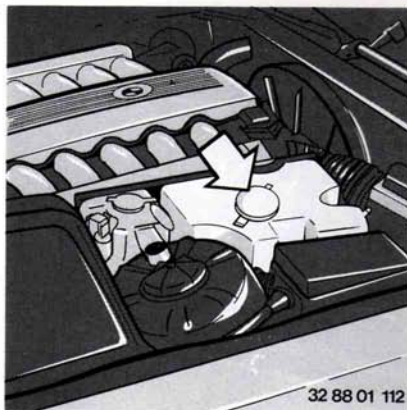

Reservoir for windshield washer, headlight and fog light cleaning systems * – BMW 750i/iL

Capacity approx. 9.0 l (15.8 pints); without headlight and fog light cleaning system approx. 6.5 l (11.4 pints).

Filling: as described above.

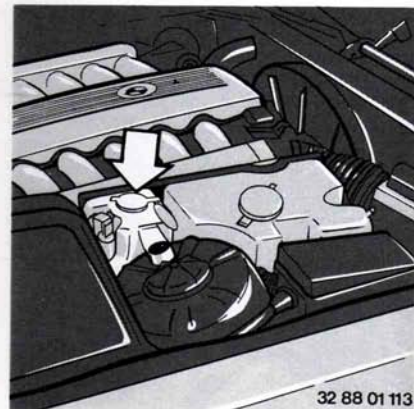

Reservoir for intensive windshield cleaner – BMW 750i/iL

Capacity approx. 1.0 l (1.8 pints).

Filling: as described above.

Windscreen washer jets

The jets of fluid should strike the windscreen at a suitable point to ensure effective cleaning even at high road speeds.

If necessary, adjust by inserting a needle and moving the jets.

Headlight and fog light cleaning system jets

Your BMW service station will reposition these jets on request.

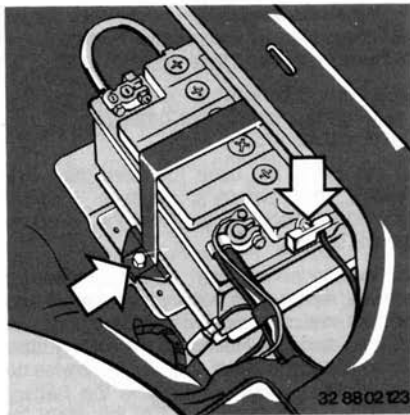

Battery

The battery needs no maintenance and complies with DIN 43 539 standard, Part 2. The electrolyte added initially should normally last for the life of the battery, which is located beneath the rear seat.

Access to the battery: lift up rear seat.

If the acid level falls too low, for instance after a long stay in a hot climate, top up with distilled water (not acid).

The acid level should be app. 5 mm (0.2 in) above the tops of the plates, level with the marks visible in the cell openings.

Keep the upper part of the battery dry and clean.

Cars with electric rear seat adjustment:

Any work on the battery should be carried out by a BMW service station.

Starting with a flat battery: see Page 88.



Please read the following notes before performing any work on the battery:



Always wear eye protection. Particles containing acid or lead must never be allowed to come into contact with the eyes, skin or clothing.



Battery acid is caustic. Always wear protective gloves and goggles. Do not tilt the battery, otherwise acid could leak out through the gas vents.



Keep the acid and battery out of the reach of children.



Never bring a naked flame near the battery or cause sparks in its vicinity. Do not smoke when handling the battery. Avoid creating sparks when handling leads and electrical equipment. Avoid short-circuits. Never short-circuit the battery terminals, as the resulting arc could cause severe injury.



A highly explosive detonating gas is generated when the battery is charged.



If acid comes into contact with the eyes, rinse immediately with clean water for several minutes and consult a physician without delay. Neutralise acid spillage on the skin or clothes immediately with soap and rinse off with plenty of water. If acid has been swallowed, consult a physician immediately.



In order to protect the housing against ultraviolet radiation, do not expose batteries to direct daylight. As batteries which have run flat could freeze, store in a place where there is no risk of frost damage.

Never detach the battery leads when the engine is running, or else an overvoltage will occur and damage the car's electronic equipment beyond repair.

Disconnect the negative terminal first, then the positive terminal. Release the battery screw connection.

When installing again, connect the positive terminal first, followed by the negative terminal.

When the engine is at a standstill, only recharge the battery while still fitted to the car. The easiest way to recharge the battery is via the terminal in the engine compartment (positive terminal) and earth – see point 4 of the section "Starting with a flat battery".

Before attempting any work on the car's electrical system, always disconnect the negative lead from the battery to avoid the risk of short-circuits.

To do this, an earth (ground) connection on the right of the seat base can be disconnected; access to the battery itself is then not necessary:

- Pull off the cover
- Release screw and remove holder
- Remove nut and take off earth lead.

If a second battery* is installed in the luggage compartment, this battery must also be disconnected.

If the car is not used for more than four weeks, the battery's negative terminal should be disconnected from the on-board power supply.

If the car is not used for more than six weeks, remove the battery, recharge it and store it in a cool place where there is no risk of frost damage. Recharge the battery after 3 months at the latest, as it will otherwise be rendered useless. Every time the battery runs flat, particularly if left in this state for any length of time, its operating life is reduced.



Hand in spent batteries at a collection point for used batteries or at your BMW service station. Batteries filled with acid should be transported and stored upright. Protect batteries against falling over when in transit.

Note:

When indicating the next change of brake fluid, the Service Indicator does not take into account periods during which the battery has been disconnected.

Any such times must be taken into account to ensure that the brake fluid is changed according to schedule every two years, i.e. it will be necessary to change the brake fluid before the clock symbol lights up.

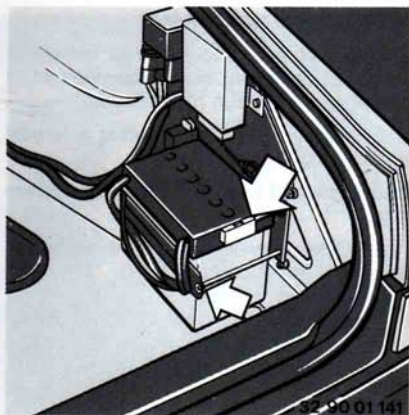

Second battery* in luggage compartment

The care and maintenance instructions on the previous page also apply to this battery.

Warning:

- If this battery has to be recharged, connect the charger directly to its poles only.
- Never use this battery as a starting aid if another battery is flat.

The battery can be reached by removing the cover trim.



Fuses

If an item of electrical equipment should fail, switch it off and check the fuse.

The **fuse box** (power distribution box), with spare fuses, relays and plastic tweezers is located in the engine compartment on the left.

Take off the fuse box cover by pressing the hoop to one side.

Pull the blown fuse out of its socket with the plastic tweezers. If the metal wire inside the fuse has melted, the fuse must be renewed, using a fuse of the same rating.

Never attempt to repair blown fuses.

To close the fuse box, push the cover down and press the hoop on at the side.

If a fuse blows repeatedly, have the fault repaired by a BMW service station.

There are more fuses beneath the rear seat on the left. On models with a trailer tow hitch, the trailer lights are also protected by fuses in the trailer module in the luggage compartment, behind the left-hand side trim. The fuse for the permanent positive line is located on the right beneath the rear seat in a separate fuse box next to the battery.

A list of fuses together with their rating and equipment supplied is on the fuse box cover.

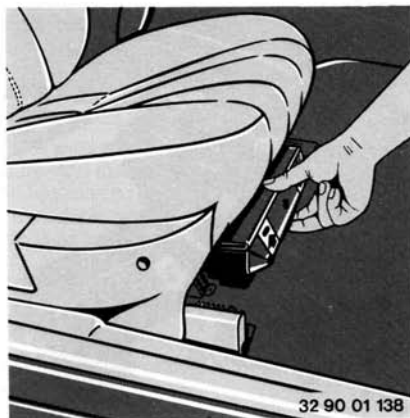

First aid box *

This item is stored in a holder under the front passenger's seat.

To take it out, raise the locking catch behind the recessed handle and pull the first aid box forward.

When returning the box to its holder, press it down slightly to ensure that the locking catch engages.

Comply with legal requirements with regard to carrying a first aid kit.

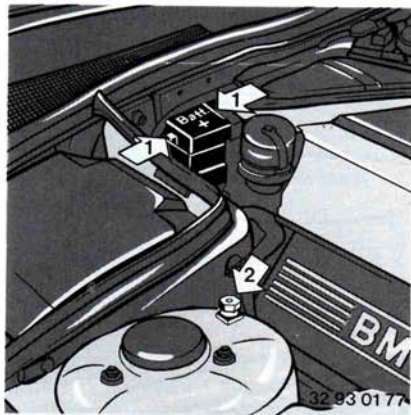

Starting with a flat battery

If the battery is run down, the engine can still be started by connecting two jump leads* from a second vehicle.

1. Check that the second car has a 12 V electrical system and a battery of approximately the same capacity in Amp/h (this will be marked on the battery).
2. Leave the flat battery connected to the car's electrical system.
3. Do not allow the bodywork of the two cars to touch, or a short-circuit may be caused.

4. First connect the positive terminals of the two batteries together. A special connection is provided in the engine compartment for this purpose (cap marked "Batt. +"; pull tab to remove (BMW 730i 6-cylinder, 750i/iL) or pull tabs on both sides (BMW 730i 8-cylinder, 740i/iL) – see illustration, arrow 1). Then connect the batteries' negative terminals. To do this, first connect one of the jumper leads to the negative terminal of the second battery or to part of the engine or body of the second vehicle, then connect it to the earth (ground) of the engine or body of the car that needs to be started (nuts on the spring strut dome, see arrow 2 in illustration of BMW).

Caution:

Observe the correct order when jump-starting other vehicles, to avoid generating sparks at the battery.

5. If the battery of the second car is also weak, run its engine to boost the charge. Start your own car's engine in the usual way and keep it running. After the engine has started and **before disconnecting the jump leads**, switch on the lights, rear window heater and maximum heater blower speed to avoid an overvoltage between the governor and consumer equipment. Disconnect the jump leads in the opposite order to that described above. Depending on the cause of the fault, have the battery recharged.

Warning:

The car is equipped with a high-performance ignition system and any contact with live components while the engine is running could cause a **fatal electric shock**.

Adhere strictly to the procedure described, otherwise harm to persons or damage to both cars may occur.

BMW 730i 8-cylinder, 740i/iL, 750i/iL

Because of the special air mass measuring system used in the Digital Motor Electronics, **do not spray any starting aids** into the air intake.

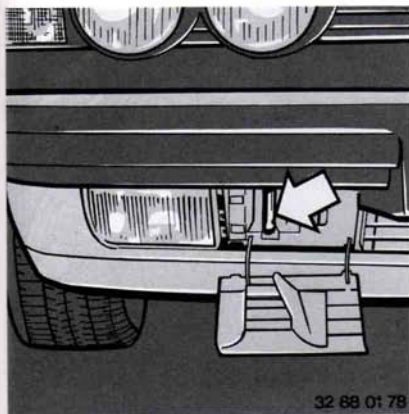

32 88 01 78

Towing facilities

Front towing eye on right: remove the cover.
Rear towing eye: press the cover panel out, using a screwdriver inserted at the arrows.

Use nylon towropes or straps which are resilient enough to protect both vehicles against sudden jerking. Alternatively, a towbar may be used.

When using a towbar, both cars' towing eyes should be on the same side.

If the towbar runs at an angle, note the following:

- the amount of free movement between the cars is limited on bends

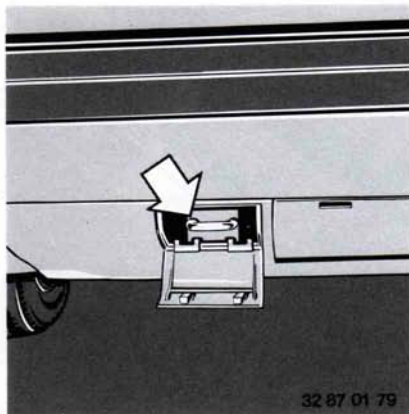

32 87 01 79

- the angle of the towbar gives rise to lateral forces (particularly dangerous on slippery road surfaces)
- do not attempt to steer the car being towed along the same line as the towing vehicle
- there is a danger of the towed car jackknifing when the towing vehicle is braked.

Important:

The vehicle being towed should not be heavier than the towing vehicle.

Tow-starting

Switch on the hazard warning flashers if required by law (note national regulations).
Switch on the ignition, engage 3rd gear and keep the clutch depressed.

De-clutch again when the engine starts.
Switch off the hazard warning flashers.
The cause of poor starting should be investigated and put right by a BMW service station.

Cars with automatic transmission

Cars with automatic transmission must not be tow-started.

To start the car if the battery is flat, use jump leads as described on the previous page.

Towing away

If the vehicle has to be towed away, turn the ignition key to position 1 so that the brake lights, turn indicators, horn and wipers are operational.

Switch on the hazard warning flashers if required by law (comply with national regulations).

If the electrical system is out of action, the towed car must be identified as such (for instance by placing a notice or the warning triangle in the rear window).

Cars with automatic transmission

Selector lever at N.

Towing speeds:

BMW 730i 6-cylinder, 750i/iL:

max. 50 km/h (31 mile/h).

BMW 730i 8-cylinder, 740i/iL:

max. 70 km/h (43 mile/h).

Towing distances:

BMW 730i 6-cylinder, 750i/iL:

max. 50 km (31 miles).

BMW 730i 8-cylinder, 740i/iL:

max. 150 km (93 miles).

Warning: when the engine is not running, the power assistance for the brakes and steering does not operate. Increased effort is then required to operate these systems.

Toolkit

The toolkit is located on the underside of the luggage compartment lid. Access is by unscrewing the wing nut.

Warning triangle *

This item is stored ready to hand in the toolkit.

Comply with legal requirements with regard to carrying a warning triangle.

Fire extinguisher *

Holder on the driver's seat.

To ensure full operational reliability, have the fire extinguisher examined by an authorized service station every 2 years.

If these service stations are not listed on the extinguisher or any documentation available to you, please consult a local trade directory or the "yellow pages" of the telephone service to obtain the address.



Wheel changing

Apply the handbrake and select 1st or reverse gear. On automatic transmission cars, select P.

If a tyre punctures, protect the car by switching on the hazard warning flashers and positioning a warning triangle or flashing lamp at an appropriate distance behind the car. Note legal requirements in this respect.

Spare wheel

Located under the luggage compartment floor mat. Unscrew the retaining nut by hand.



Car jack and wheel stud wrench

Located on the rear wall of the luggage compartment. Take off the trim (by opening the quick-release fasteners). To prevent noise after putting the jack back in the luggage compartment, retract it fully and secure it in its original position with the wing nut.

Wheel chock

The wheel chock is located in the luggage compartment next to the jack and held firmly to prevent noise. Depending on the slope, place the chock in front of or behind the opposite rear wheel to prevent the car from rolling away when it is lifted by the jack (the design of the handbrake renders this precaution essential).

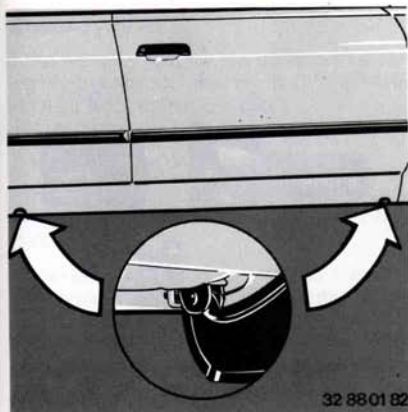

32 88 01 82

Pressed-steel wheels: remove the full-width wheel cover by hand.

Light-alloy wheels: press off the wheel stud cover with a screwdriver.

Wheel stud covers in the form of a large hexagon nut: turn this counter-clockwise with the hexagon wrench and with the aid of the wheel stud wrench. The large hexagon wrench is kept in the luggage compartment under the spare wheel cover to release the bayonet catch.

Loosen the wheel studs.

Attach the jack to one of the **four pick-up points** (the one nearest the punctured tyre) so that the foot of the jack is squarely on the ground. Turn the jack handle until the wheel is clear of the ground.

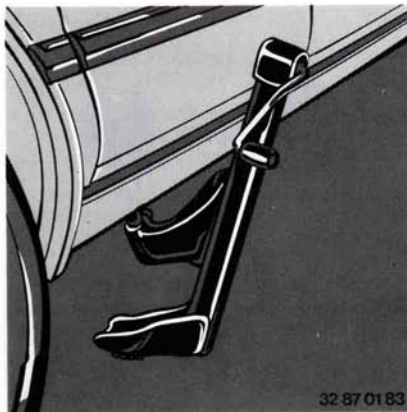

32 87 01 83

Warning:

Use the car's jack only for wheel changing. Never try to use it to raise a different car or any other kind of load, or else accidents and personal injury may occur.

Warning: never lie underneath a jacked-up car, or else you risk a fatal accident.

Unscrew and remove the wheel studs and change the wheel.

To fit the new wheel, insert the centring pin from the toolkit into one of the tapped holes. Place the wheel on the pin, screw in one wheel stud, then remove the pin. Screw in the remaining wheel studs and tighten them uniformly.

Lower the car with the jack. Tighten the wheel studs firmly in a crosswise pattern (first one stud, then another on the opposite

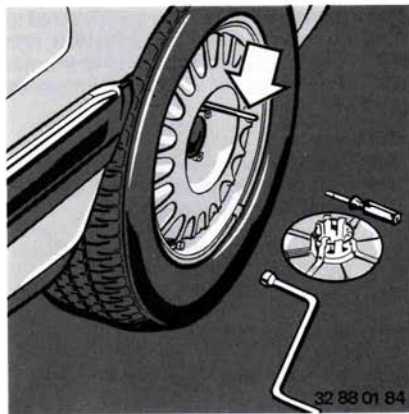

32 88 01 84

side of the wheel). For safety reasons, have the tightening torque (110 Nm) checked with a calibrated torque wrench at the earliest opportunity.

When a wheel is installed for the first time (e. g. the spare wheel), check the tightening torque after the first 1000km (600 miles).

When fitting other than Original BMW alloy wheels, it may be necessary to use the corresponding wheel studs in place of the standard BMW studs.

To attach the **full-width wheel cover**, the tyre valve must be at the bottom. First place the cover against the rim at the valve side, then hold it in this position with the foot and press it up with both hands.

Have the flat tyre repaired and the wheel balanced as soon as possible.

Tyre repairs should always be entrusted to a BMW service station or specialist tyre dealer capable of examining the tyre to determine the full extent of possibly concealed damage.

Important:

When removing or renewing tubeless tyres, the rubber valve must always be renewed as well as a safety precaution.

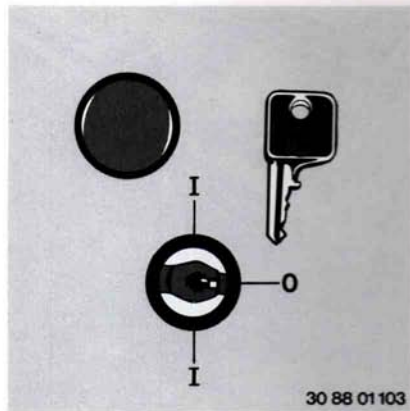

Lockable wheel studs *

Take off the end cap, using the edge of the key if necessary.

Insert the key in the lock, turn it app. 90° in either direction and lift off the lock.

O = Locked
I = Unlocked

Fit the lock by following the same procedure, but in the reverse sequence. Hold the lock tight when pulling out the key.

Note:

The lockable wheel stud should always be fitted opposite the tyre valve.

Recommendation: to ensure that the lockable wheel studs can always be removed when necessary (in the workshop, for example), keep a key in the car's toolkit.

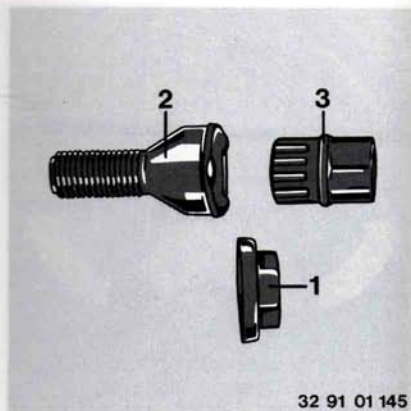

Thieftproof wheel studs *

- 1 Cap (not on wheels with wheel stud covers)
- 2 Wheel stud for adapter
- 3 Adapter (two supplied in toolkit)

To remove:

- Turn the cap (1) slightly to the left with the wheel stud wrench and remove it.
- Take an adapter (3) from the car's toolkit and insert it into the wheel stud.
- Unscrew the wheel stud (2).

After inserting and tightening the wheel stud again, remove the adapter and press on the cap.

The code number is stamped on the face of the adapter. Please note this number and keep this information in a safe place in case the adapter is lost.

Brake system

If the warning light for the brake and steering hydraulics comes on (LOW BRAKE FLUID Check Control display):

- loss of brake fluid is indicated by increased brake pedal travel.

If the warning light flashes (BRAKE PRES-SURE in Check Control display, only BMW 750i/iL):

- greater pedal effort is required if loss of reservoir pressure has put the brake booster servo out of action.
- the power steering becomes stiff to turn if system pressure loss has deprived the steering of its power assistance.
- increased pedal effort and stiff power steering indicate that the hydraulic pump is out of action, possibly as a result of a broken V-belt.

Failure of one brake circuit

Pedal travel will increase and greater pedal effort will be needed.

The car can still be braked satisfactorily with only one circuit in operation.

As for all brake system faults, the car should be taken to a BMW service station for immediate repair.

BRAKE LININGS warning in Check Control:

- brake pads worn/renew without delay.

Important:

Use only brake linings approved by BMW, or else the car's general operating permit will be rendered invalid.

Power steering

If the steering becomes stiff, check the oil level (see Page 80).

If the steering is stiff only when the wheel is turned quickly, the V-belt is slack. Have it retensioned or renewed.

If these measures prove ineffective, consult a BMW service station.

Cars with Servotronic*:

If steering becomes increasingly light in action at high road speeds, there is a malfunction in the electronic control system.

Warning:

If the power assistance fails, a greater force than usual must be applied at the steering wheel to steer the car.

Self-levelling suspension *

If the SUSPN LEVELLING display appears in Check Control:

If the car is **overloaded** (rear end of car has dropped noticeably), reduce the load on the car to comply with the permitted rear axle load limit. When normal working conditions have been restored, the display will disappear.

If there is a **defect in the self-levelling system**, consult a BMW service station. Do not exceed a road speed of 170 km/h (106 mile/h), since the increased rear-wheel camber angle imposes more severe loads on the tyres.

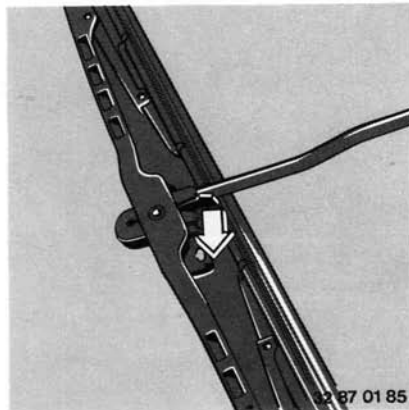

Windscreen wipers

Renewing a wiper blade:

Lift up the wiper arm.

To change the blade on the driver's side, first pull the outer retaining spring and then the inner one (arrow) until the wiper blade can be disengaged.

There is only one retaining spring on the front passenger's side.

Pull the wiper blade towards the wiper arm to remove.



Sliding/vent roof

Mechanical operation in the event of electrical failure:

Remove the cover. Insert and turn the Allen key (from the toolkit) to move the sunroof panel in the desired direction.

Have the fault repaired without delay by a BMW service station.

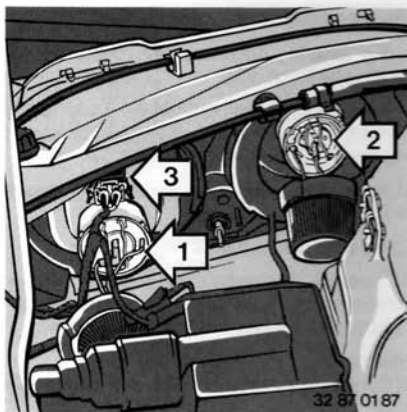

Changing bulbs

When performing any work on the car's electrical system, always switch off the item concerned or disconnect the battery negative lead to avoid the risk of short-circuits.

Do not hold new bulbs with bare fingers. Use a clean cloth, paper towel or similar, and only hold the base of the bulb.

A box of spare bulbs for emergency use is available from BMW service stations.

Low beam headlights (1)

55 Watt H 1 halogen bulb

Remove the headlight cover, turn the plastic cap to the left and pull it off the rear of the headlight unit.

Release the wire spring clip, pull the plug off the bulb and renew the bulb.

BMW 750i/iL: take off the air cleaner if necessary before changing bulbs.

High beam headlights (2)

55 Watt H 1 halogen bulb

Same bulb-changing procedure as low beam headlights.

To prevent water entering through loose outer covers, make sure that all the pins of the bayonet catch engage when attaching the covers.

Parking and side lights (3)

5 Watt bulb

Press the bulb holder in slightly and turn it to the left to remove. Pull out the bulb.

Xenon lights *

The light source of this dipped headlight is a 35 Watt gas discharge bulb (D1 = discharge version 1). The headlights only come on when the engine is running.

When switched on, a high electric charge is passed through the pressurised gas (xenon) inside the bulb. The full lighting effect is achieved after a slight delay. Appropriate safety circuits are installed as a precaution. If a headlight cover is damaged, the headlight itself cuts out.

The light yield, which is almost three times that of conventional headlights, illuminates in particular the area in front of the car and along the roadside with the aid of the special optical system.

The bulb has an extremely long operating life. Signs of bulb fade include flickering, a marked reddish hue and a decline in light intensity. Unnecessary switching on and off shortens bulb life.

If a bulb fails, you may continue your journey using the fog lights (where permitted by law) and adopting a suitably cautious driving style. Dazzling headlights (e. g. if the self-levelling suspension is faulty) must be adjusted as appropriate by hand.

Warning:

Any work on the lights system, including bulb-changing, should only be carried out by suitably qualified personnel.

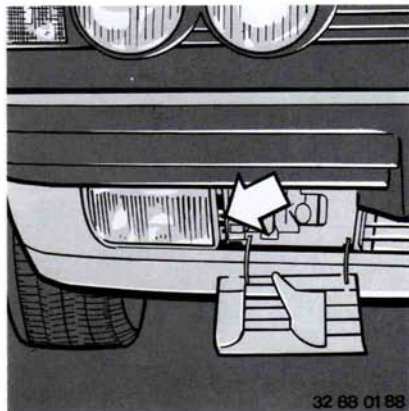

Front fog lights

55 Watt H 1 halogen bulb

Pull off the cover next to the fog light. Remove the lower Phillips-head screw (arrow) and swing the light assembly out. Turn the cover to the left and remove it from the back of the light. Release the wire spring clip and renew the bulb after detaching the plug from it.

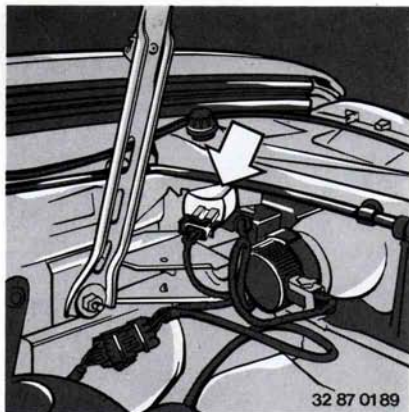

Front turn indicators

21 Watt bulb

Press the bulb holder in gently and turn it to the left to take it out. Repeat this procedure to remove the bulb from the holder.

Side turn indicator repeaters *

5 Watt bulb

Remove the Phillips-head screw and push the housing forwards out of the side panel. Turn the bulb gently to the left to remove.

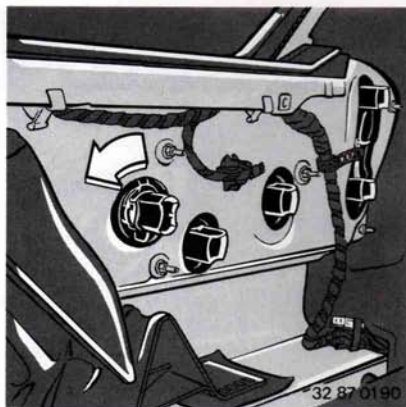

Rear light cluster

Rear lights: 5 Watt bulb

Other lights: 21 Watt bulb

Open the luggage compartment lid and take off the rear-panel trim after opening the quick-release fasteners.

Turn the holder of the affected bulb to the left, pressing in slightly, and remove it. Remove the bulb from the holder in the same way.

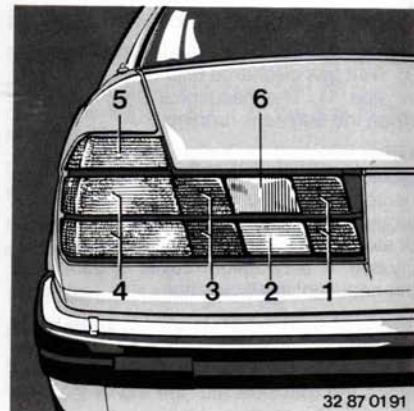

- | | |
|---------------------|----------|
| 1 - Rear fog light | (red) |
| 2 - Reversing light | (white) |
| 3 - Brake light | (red) |
| 4 - Rear light | (red) |
| 5 - Turn indicator | (yellow) |
| 6 - Reflector | (red) |

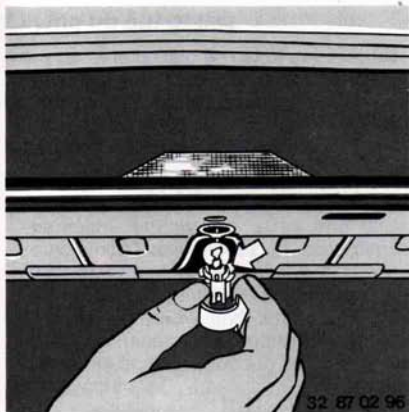

32 87 02 96

Central brake light *

21 Watt bulb

Open the luggage compartment, turn the bulb holder to the left while pressing it in slightly, and take it out. Remove the bulb from the holder in the same way.

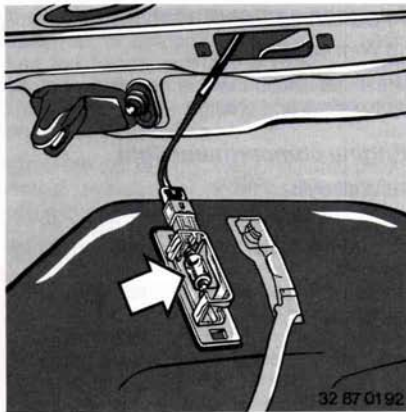

32 87 01 92

Licence plate light

5 Watt bulb

Lever out black trim cover with a screwdriver at one of the side recesses.

Remove the Phillips-head screws and take off the lens frame with rubber seal. Pull the bulb out of the contact blades.



32 88 01 102

Footwell lights

5 Watt bulbs

Take off the glass (if necessary lever off carefully by inserting a screwdriver at the bottom) and press the bulb in slightly while turning it to the left to remove.

Interior lights

Front: 10 Watt bulbs

Press out lens with a screwdriver at the left-hand recess. Pull the bulb out of the contact tongues.

In conjunction with reading lights:

Interior light: 15 Watt bulb

Reading lights: 10 Watt bulbs.

Press out bulb with a screwdriver at the left-hand recess.

Interior light: press back the plastic tab on the reflector, fold open the reflector and remove the bulb.

Reading light: press the bulb in slightly and turn to the left to remove.

Rear: 10 Watt bulbs

Press out the bulb with a screwdriver at the side recess. Fold open the reflector and change the bulb.

Reading light: press the bulb in slightly and turn to the left to remove.

Luggage compartment lights

10 Watt bulbs

Press out the bulb with a screwdriver at the side recess and change.

Engine compartment light

10 Watt bulb

Press the clip away from the glass with a screwdriver, take off the glass and renew the bulb.

Laying up out of use

If the car is to be laid up out of use for **more than three months**, we recommend that the following maintenance work be carried out by a BMW service station to prevent deterioration during the storage period.

1. Clean and apply protective or preservative treatment to the engine, engine compartment, underbody, axles and other mechanical assemblies in accordance with BMW factory instructions. Wash the body, clean the interior and clean or protect the paintwork and chromium-plated parts as necessary. Clean rubber seals on doors and lids, and rub them with talc or glycerin.
2. Change the engine oil and renew the filter element while the engine is at normal operating temperature. As an additional anti-corrosion measure, a corrosion inhibitor can be added to the engine oil in accordance with the supplier's instructions.
3. Check coolant level and concentration, and correct if necessary.
4. Check acid level in the battery cells and top up with distilled water if necessary.
5. Drain the windscreen washer fluid tank and lines.
6. The fuel tank should be filled to prevent corrosion caused by moisture condensate.
7. Increase tyre pressures to 4 bar (app. 57 lb/in²).

Drive the car immediately before it is to be taken out of use and apply the foot brake and the handbrake until sufficient heat is generated to dry out the brake pads and linings and ensure that the brake discs and drums cannot corrode.

Store the car in a dry, well-ventilated place. Select reverse gear (P on cars with automatic transmission). Do not apply the handbrake; if necessary, chock a wheel to prevent the car rolling away.

Remove the battery, recharge it and store in a cool place where it will be protected against frost. The battery must be recharged at least every 3 months, or it will become unsuitable for further use. Every time the battery runs flat, particularly if left in this state for any length of time, its operating life is reduced.

The air conditioning, if fitted, must be run briefly at least once a month; this is particularly important in the cold season of the year, to prevent the compressor-shaft seals from drying out and allowing refrigerant to leak. The engine should be run for this purpose until it reaches normal operating temperature (coolant temperature gauge needle approximately midway between the two coloured zones). This will prevent condensate from forming, and avoid the risk of internal engine corrosion. If the car is not equipped with air conditioning, do not run the engine during the storage period.

Warning:

For the reasons stated above, never run the car's engine in an enclosed space unless adequate ventilation is provided, to ensure that no toxic fumes are inhaled.

Note that if the car's registration was allowed to lapse or the car was officially taken out of use, the proper legal procedure and the time limits for re-registration must be carefully observed, or else the general operating permit may be invalidated.

Comply with your national regulations.

Restoring car to use

First recharge the battery or renew it if necessary.

A BMW service station should then perform Inspection I.

Note:

When indicating the next change of brake fluid, the service indicator does not take into account periods during which the battery has been disconnected. Any such times must be taken into account to ensure that the brake fluid is changed according to schedule (every two years or one year), i.e. it will be necessary to change the brake fluid before the clock symbol lights up.

Winter operation

The winter months often bring with them severe changes of weather, and you must not only adopt a correspondingly cautious attitude to driving but also take certain precautions to ensure that your car comes through the winter months reliably and without breakdowns.

On winter roads, tyre grip is often very poor, and the driver must remember that braking distances are much greater than usual in many situations.

Before the cold season of the year commences, you are recommended to take your car to a BMW service station for the necessary winter preparations to be carried out.

Comply with the appropriate **engine-oil requirements**, and do not wait until the next scheduled oil change to fill the engine with winter-grade oil if the weather turns cold suddenly.

Apart from checking oil levels, no special winter operating precautions are needed on the manual gearbox/automatic transmission, final drive, power steering, hydraulic brake system or self-levelling suspension.

The coolant already contains a **long-life antifreeze and corrosion inhibitor**. To ensure full corrosion protection, its concentration must be kept at 40% all the year round (BMW 750i/iL: 50%). This provides antifreeze protection down to approx. -27°C (-16.6°F) [BMW 750i/iL: -37°C (-35°F)].

Use only factory-approved, nitrite-free and amino-free long-life antifreeze and corrosion-inhibiting additives. BMW service stations know the approved grades.

Renew the coolant **every 2 years**. Check antifreeze concentration before and during the cold season of the year. At the same time, inspect the cooling system for leaks and renew any coolant hoses which have become porous or brittle.

Engine temperature is regulated by the coolant thermostat according to engine load and outside temperature. For this reason, no radiator blind or grille blanking-off material should be used.

The engine will not start reliably unless the **battery** is fully charged. Remember that a cold battery is less efficient, yet the demands made on it are more severe than in warm weather.

Use only factory-approved care products* on the **locks**. These products also help prevent the locks from freezing; but if a lock should freeze despite these precautions or due to a defective door-lock heating system, the key can be heated before inserting to thaw out the lock.

Do not use de-icer as it has a degreasing effect and will impair the functioning of the locks.

To prevent **rubber seals** on doors and lids from freezing, treat them with a rubber-care product* or silicone spray*.

The car's **paintwork**, as well as **chromium plated or polished metal parts**, should be protected before and during the winter months by applying suitable bodywork care products*.

Have your car's brakes checked as a precaution before and after each winter driving period by a BMW service station. This work can usually be combined with whatever maintenance routine happens to fall due.

* Available from BMW service stations

In cold weather, we recommend carrying the following items in case of emergency:

A quantity of **sand** to aid starting on ice-covered slopes.

A **shovel** to dig the car out of snowdrifts.

A **plank** to act as a support for the car's jack.

A **brush and ice scraper** to clear the windows and body panels if covered with snow or ice.

BMW snow chains* for all severe winter driving conditions can be used on winter and summer tyres, but always only in pairs and on the driven (rear) wheels. Always observe the tyre manufacturer's safety recommendations.

With snow chains fitted, a speed of 50 km/h (31 mile/h) should not be exceeded.

Always comply with the local speed regulations of the country in which you are driving.

Any BMW service station will be pleased to provide further details.

Winter driving hints

When planning a fairly long journey in winter, allow plenty of time in case severe weather conditions and bad roads are encountered. Local newspapers, radio and TV, the telephone service and the automobile clubs provide information on local road conditions, and also whether certain mountain passes are open to traffic.

Before starting the journey, remove ice and snow from the windows, outside mirrors and lights. After a heavy fall of snow, clear the roof and the engine and luggage compartment lids as well. Clear snow away from the entry grilles for the heating/ventilation system at the rear of the engine compartment lid, so that the airflow is not impeded.

Before getting into the car, try to remove slush, snow and ice from your shoes to avoid the risk of slipping off the pedals. Driving in ski boots is definitely not recommended, as it is difficult to operate the pedals with the sufficient degree of sensitivity.

After starting a cold engine, particularly at temperatures below -15°C ($+5^{\circ}\text{F}$), the gear lever may be stiff and the car's suspension may not respond smoothly for the first few minutes of the journey, and other items of equipment may be noisier than usual. This is unavoidable while the oil is still cold and viscous.

When **driving on a slippery surface**, operate the accelerator pedal slowly and smoothly, and avoid high engine speeds by selecting a higher gear quite early. Keep a particularly generous safety margin between your car and the vehicle in front. Select the next-lower gear in good time before reaching an uphill or downhill gradient.

To improve starting on icy or snow-covered roads and in hilly country when the car is only lightly laden, 30–50 kg (66–110 lb) of ballast can be carried in the luggage compartment. Make sure that the ballast is firmly secured and cannot slip.

If skidding occurs, ease back the accelerator and disengage the clutch by pressing the clutch pedal down; on automatic-transmission cars, push the selector lever to N. Try to steer into the skid and get the car back under control in this way.

When **braking**, wheel locking is prevented by the ABS, so that the car remains stable and can be steered.

Should the ABS fail, the wheels may lock when conditions are unfavourable. Reduce pressure on the brake pedal until the wheels are just rotating but are still braked. Then increase pedal pressure again until the wheels lock, release it again etc. Repeat this "cadence braking" sequence as often as possible: it shortens total braking distance and the car remains steerable, so that you have a chance of driving round an obstruction with which you might otherwise collide.

Warning:

On a slippery surface, do not shift to a lower gear as a means of braking the car, or the rear wheels may lock and cause the car to skid or the driver to lose control. This is also the case on cars fitted with ASC* or ASC+T* if this system is faulty or switched off. ABS cannot counteract this form of wheel locking.

Note: when braking heavily on a slippery surface or one providing markedly varying amounts of grip, always declutch.

If the car is immobilized in deep snow, sand or soft ground, pack some firmer material under the rear wheels to provide extra grip before the car digs itself in too far. If nothing else is available, use the car's floor mats. With a degree of skill, the car can be "rocked" out of the holes: use a light throttle opening and select a forward gear and reverse in quick succession, and accelerate only when the car is moving in the desired direction. Avoid wheelspin, however, or the car will sink in deeper still. The handbrake can be applied lightly to prevent one rear wheel from spinning.

Warning:

If the car becomes immobilized in snow or sand, make sure that the exhaust pipes and the surrounding area are clear of snow or sand when the engine is running. There is otherwise a risk of odourless but highly toxic carbon monoxide entering the car and rendering the occupants unconscious or even having fatal consequences. Open a window slightly on the side of the car away from the wind to ensure an adequate supply of fresh air.

Snow chains are permitted only in pairs on the driven (rear) wheels. If available, fit them **in good time**. They increase driving safety on snow and ice, enable the car to climb hills without slipping and reduce braking distances.

However, the driver must become accustomed to the car's changed handling characteristics. Remove the snow chains as soon as possible, as they wear out very rapidly on clear roads.

During a break in the journey or when filling the tank, remove **built-up snow and ice from inside the wheel arches**, to ensure that steering and suspension movements are not impeded.

When **parking** your car, prevent it from rolling away by selecting 1st gear or reverse as appropriate, or P on the automatic transmission. Apply the handbrake if parked on a slope. To prevent the handbrake linings from freezing to the drums in cold weather and to avoid corrosion, apply the handbrake to bring the car to a standstill from slow speed, so that the linings and drums are dried by the heat thus generated.

Useful information on disc brakes

A disc brake system offers optimum braking efficiency, smooth response and high load capacity. The high temperatures which occur during brake applications, for instance when driving hard in hilly areas, necessitate maximum cooling; this is provided by ram air and by the speed of rotation of the brake discs. Severe loads on the brakes affect the temperature of the brake fluid and the pads; overheating may reduce braking efficiency or cause "fading", increased pedal travel and possibly the need for greater effort to be applied at the pedal. However, the boiling point of modern brake fluids is so high that only exceptionally severe use of the brakes or treatment amounting to carelessness on the driver's part should cause such situations to arise.

Wet conditions, dirt, salt spread on the roads in winter and brake disc corrosion can impair braking performance by increasing braking distances, altering the car's normal brake force distribution or causing variations in the coefficient of friction at the various wheels, so that the car pulls to one side.

Brake disc corrosion is accelerated if the car is used very little or is garaged for long periods.

Gentle use of the brakes, although in itself not undesirable, can encourage brake disc corrosion and allow the pads to become dirty, since the minimum pressure needed for the disc brake's self-cleaning action is not attained between pad and disc.

Corroded brake discs may result in a knocking effect when the brakes are applied; this cannot always be eliminated by prolonged braking.

On the other hand, slight corrosion and surface roughness can be removed by fitting brake pads with an abrasive corundum coating. Any BMW service station can provide information on braking during the running-in period, use of these brake pads etc.

Dirt burnt into the brake pads (glazing of rubbed area) leads to scoring of the brake discs and also a change, reduction or delay in braking effect.

Another problem in this connection is brake squeal, which tends to increase in intensity as the discs become dirtier or more glazed.

All these **climatic and environmental effects cause a change in the brakes' coefficient of friction**, that is to say less braking efficiency is available for a given pedal effort. If the coefficient of friction changes differently at the various brakes, the car may respond unevenly or pull to one side.

Recommended driving procedure for disc brakes

At intervals when traffic conditions allow, disc brakes should be applied quite hard once or twice from high speed. The resulting high braking pressure ensures that the brake pads and discs are kept clean.

Similarly, on long journeys in poor weather conditions, particularly in winter if salt has been spread on the roads, it is advisable to apply the brakes firmly from time to time when it is safe to do so. This not only tests their efficiency in the prevailing conditions (but take care at temperatures around freezing point!), but also results in a self-cleaning action to ensure that they are ready to operate efficiently even in the worst possible weather conditions.

In wet weather and when rain is actually falling, it is advisable to apply the brakes briefly at light pedal pressure at relatively frequent intervals during the journey. The heat generated in this way keeps the discs and pads dry for a certain period.

Before parking the car after driving through rain, and particularly if salt has been spread on the roads, lightly brake the car to a standstill so that the brake discs are dried and cannot corrode so easily.

If brake disc corrosion has already occurred, it can be eliminated in its early stages by braking the car heavily several times. Make sure that other road users are not endangered.

The most effective braking action is always achieved not with locked wheels, but when the wheels are still just turning, the result obtained by the antilock braking system.

If the antilock braking system should fail, apply cadence braking (see Page 101).

Locking the wheels can be dangerous, as locked front wheels can no longer be steered, and locked rear wheels cause the car to skid sideways or spin.

If the brake pads are severely corroded or the pads are very dirty (glazing of rubbed surfaces), they must be examined, cleaned, reconditioned or renewed by a BMW service station.

Even long, steep downhill gradients in the mountains need not adversely affect the action of the brakes if you select the correct gear ratio or automatic-transmission speed range to ensure the required degree of engine braking as well. The engine braking effect is higher in the lower gears; in extreme cases, shift right down to 1st gear or selector lever position 2 or 1.

If the engine braking effect is still not sufficient to prevent the car from descending a hill faster than intended, it is wrong to apply the brakes continuously at light or medium pedal load. Instead, brake the car to a safe speed using quite high pedal pressure (but with due consideration for following traffic), then apply the brakes again at intervals to keep the speed down. The cooling phases between brake applications help to avoid overheating and the risk of brake fade.

Never drive with the clutch pedal depressed, the gear lever or automatic transmission selector in neutral or – still more dangerous – with the engine switched off at the ignition. In neutral, engine braking is entirely lost, and if the engine is switched off the brake booster servo is no longer able to reduce pedal pressure in the normal way.

Warning:

Unrestricted movement of the brake, clutch and accelerator pedals must never be prevented by the floor mats, carpet or any other objects.

What you should know about tyres

Information for your safety

The factory-approved radial-ply (braced tread) tyres have been chosen to match your car's performance and to ensure driving safety and the desired standard of ride comfort.

The condition of the tyres and maintenance of the specified tyre pressure not only influence tyre life but also road safety to a very considerable extent.

Incorrect tyre pressures are often a cause of tyre problems. They also have a considerable effect on the roadholding of your BMW.

For your own safety you are recommended to check tyre pressures **regularly**, before starting a long journey and in any case **at least once every two weeks**.

Make sure in particular that the specified tyre pressures are maintained if the load on the car is increased and when driving at high speeds for extended periods. Lower pressures than those specified will reduce stability and driving safety, because lateral locating forces are lower. The tyres will be less capable of withstanding high speeds and will heat up more rapidly as a result of excessive flexing. The associated higher roll resistance will cause fuel consumption to deteriorate and could lead to tyre damage and accidents.

It should be remembered that if a tyre suffers concealed damage it may only fail much later or when exposed to a less severe load.

If a tyre loses pressure severely, always have the cause investigated and put right. Remember to check the spare wheel's tyre pressure too, and keep this app. 0.3 bar (3–4 psi) higher than the specified value for heavier loads, so that the tyre can always be fitted without having to be inflated further.

Higher tyre pressures reduce ride comfort and lead to premature tread wear.

Warning:

Over-inflating the tyres can cause tyre damage or, in certain circumstances, sudden loss of pressure, because the tyres are more sensitive to loose objects on the road or sharp-edged potholes.

Tyres are exposed to very severe loads at high speeds, particularly in hot summer weather and when the car is heavily laden. Please comply with the specified higher tyre pressures for heavier loads, and **do not exceed the permitted axle loads**.

Tread depth and tyre damage

Inspect tyres frequently for damage, the presence of foreign bodies, unusual wear and sufficient tread depth.

Although the law in many countries calls only for a **minimum tread depth** of 1.6 mm (if indeed any minimum figure is laid down), you are recommended to replace tyres when the tread depth is down to 3 mm, or else the risk of aquaplaning even on shallow water will be increased.

Since the danger of aquaplaning always increases with the car's road speed, this should be kept down if the road is wet and the tyres are known to be fairly well worn. We recommend fitting new tyres when the treads are 3 mm deep. If a tyre remains in use after this, wear indicators 1.6 mm from the main rubber surface are exposed as a sign that the legal wear limit has been reached (for instance, this legislation took effect all over Europe on January 1, 1992).

The recutting of tyre treads for this car is forbidden, because of the risk of the carcase already having been damaged.

A sharp object may penetrate the tyre and cause a slow puncture. The resulting loss of air can only be detected if tyre pressures are checked regularly. If damage of this kind is suspected, the tyre should be inspected without delay by a BMW service station or an authorized tyre repair shop.

Drive with extreme care and at moderate speed if roads are poor or over unavoidable obstacles such as kerbstones, so that the **tyre carcass** does not incur any damage invisible to the naked eye.

The speed code letter indicates the maximum permissible speed at which the tyre is to be operated.

On summer tyres:







S = up to 180 km/h
 T = up to 190 km/h
 H = up to 210 km/h
 V = up to 240 km/h
 ZR = over 240 km/h

On winter tyres:

Q M+S = up to 160 km/h
 T M+S = up to 190 km/h
 H M+S = up to 210 km/h

Marks on steel or light alloy wheels:

6 J x 14 H 2

Rim width in inches* 
 Shoulder pattern code letter 
 Symbol for well-base rim 
 Rim diameter in inches* 
 Hump on both rim shoulders 
 2 

* TR and TD wheels: in millimetres

Protect dirt from entering the tyre valves with **screw-on dust caps**. Dirt in the tyre valve can often lead to a gradual loss of air pressure.

TD 230/55 R 390 low-section tyres with emergency-running characteristics (TD concept)*

In the event of a puncture, the emergency-running characteristics of this type of tyre enable you to drive out of hazard zones such as bottlenecks, heavy urban traffic, tunnels or building sites without any difficulty, even if the tyre is flat, so that the tyre can be changed in safety on a car park or at a filling station.

This type of tyre, if flat, can be driven app. 5 km (3 miles), or 10 km (6 miles) if a particularly cautious approach is adopted, depending on the vehicle's load and the condition of the road; maximum speed 60 km/h (37 mile/h) when driving in a straight line.

TD tyres may only be fitted on TD wheels.

Winter tyres

If **winter tyres** (M&S radial-ply) are fitted, the same make and tread pattern should be used on **all four wheels** (and preferably on the spare wheel as well) in the interests of good directional stability and steering response.

Fit only **winter tyres approved by BMW**. Any BMW service station will gladly advise you on the correct winter tyres for the conditions in which your car has to operate.

Always note and comply with the maximum speed limit for your winter tyres.

In the Federal Republic of Germany, a **notice** stating the maximum permitted speed with winter tyres fitted must be displayed in the **driver's field of view** if the car is capable of a higher top speed.

Suitable labels are available from tyre suppliers or BMW service stations.

Below a tread depth of 4mm, winter tyres become noticeably less suitable for winter driving conditions and should therefore be replaced without undue delay for safety reasons.

Keep to the specified **tyre pressures** and have the wheels and tyres rebalanced each time the wheels are changed or new tyres fitted.

Note:

Lack of expert knowledge or incorrect handling of tyres can cause damage and lead to accidents.

All work on tyres should therefore be carried out only by experts. Your BMW service station will gladly assist you.

Store wheels and tyres in a cool, dry and preferably dark place when not in use. Protect tyres against contamination by oil, grease and fuel.

The speed code letter indicates the maximum permissible speed at which the tyre is to be operated.

On summer tyres:

S = up to 180 km/h
 T = up to 190 km/h
 H = up to 210 km/h
 V = up to 240 km/h
 ZR = over 240 km/h

On winter tyres:

Q M+S = up to 160 km/h
 T M+S = up to 190 km/h
 H M+S = up to 210 km/h

Marks on steel or light alloy wheels:

6 J x 14 H 2

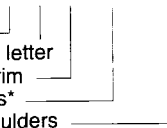

Rim width in inches*
 Shoulder pattern code letter
 Symbol for well-base rim
 Rim diameter in inches*
 Hump on both rim shoulders

* TR and TD wheels: in millimetres

Protect dirt from entering the tyre valves with **screw-on dust caps**. Dirt in the tyre valve can often lead to a gradual loss of air pressure.

TD 230/55 R 390 low-section tyres with emergency-running characteristics (TD concept)*

In the event of a puncture, the emergency-running characteristics of this type of tyre enable you to drive out of hazard zones such as bottlenecks, heavy urban traffic, tunnels or building sites without any difficulty, even if the tyre is flat, so that the tyre can be changed in safety on a car park or at a filling station.

This type of tyre, if flat, can be driven app. 5 km (3 miles), or 10 km (6 miles) if a particularly cautious approach is adopted, depending on the vehicle's load and the condition of the road; maximum speed 60 km/h (37 mile/h) when driving in a straight line.

TD tyres may only be fitted on TD wheels.

Winter tyres

If **winter tyres** (M&S radial-ply) are fitted, the same make and tread pattern should be used on **all four wheels** (and preferably on the spare wheel as well) in the interests of good directional stability and steering response.

Fit only **winter tyres approved by BMW**. Any BMW service station will gladly advise you on the correct winter tyres for the conditions in which your car has to operate.

Always note and comply with the maximum speed limit for your winter tyres.

In the Federal Republic of Germany, a **notice** stating the maximum permitted speed with winter tyres fitted must be displayed in the **driver's field of view** if the car is capable of a higher top speed.

Suitable labels are available from tyre suppliers or BMW service stations.

Below a tread depth of 4mm, winter tyres become noticeably less suitable for winter driving conditions and should therefore be replaced without undue delay for safety reasons.

Keep to the specified **tyre pressures** and have the wheels and tyres rebalanced each time the wheels are changed or new tyres fitted.

Note:

Lack of expert knowledge or incorrect handling of tyres can cause damage and lead to accidents.

All work on tyres should therefore be carried out only by experts. Your BMW service station will gladly assist you.

Store wheels and tyres in a cool, dry and preferably dark place when not in use. Protect tyres against contamination by oil, grease and fuel.

Approved BMW road-wheel and tyre sizes for summer and winter:

Radial-ply tyre (tubeless)	Pressed-steel wheel	Light-alloy wheel	Offset mm (in)
BMW 730i 6-cylinder			
205/65 R 15 94 V	6 $\frac{1}{2}$ J x 15 H2 ¹⁾ 7 J x 15 H2	7 J x 15 H2	20 (0.79)
225/60 R 15 95 V	6 $\frac{1}{2}$ J x 15 H2 ¹⁾ 7 J x 15 H2	7 J x 15 H2	20 (0.79)
TD 230/55 ZR 390		390 x 180 TD	19 (0.75)
240/45 ZR 415		195 TR 415	19 (0.75)

BMW 730i 8-cylinder

205/65 R 15 94 Q/T M+S	6 $\frac{1}{2}$ J x 15 H2 ¹⁾ 7 J x 15 H2	7 J x 15 H2	20 (0.79)
225/60 ZR 15		7 J x 15 H2	20 (0.79)
225/60 R 15 95 Q/T/H M+S	6 $\frac{1}{2}$ J x 15 H2 ¹⁾ 7 J x 15 H2	7 J x 15 H2	20 (0.79)
TD 230/55 ZR 390		390 x 180 TD	19 (0.75)
240/45 ZR 415		195 TR 415	19 (0.75)

BMW 740i/iL, 750i/iL

225/60 ZR 15		7 J x 15 H2 ²⁾	20 (0.79)
TD 230/55 ZR 390		390 x 180 TD	19 (0.75)
240/45 ZR 415		195 TR 415	19 (0.75)

¹⁾ Only certain pressed-steel wheels approved – consult a BMW service station

²⁾ Only certain light-alloy wheels approved – consult a BMW service station

Please note the wheel/tyre specifications in the car's registration documents. Use of other wheel/tyre dimensions approved by BMW may necessitate an official entry in the car's registration documents.

Winter tyres

The tyre/wheel combinations are the same as for summer tyres. Any exceptions are listed.

The use of **fine-link BMW snow chains*** with summer and winter tyres is permitted only in pairs, that is to say on both driven (rear) wheels. Always observe the manufacturer's safety instructions.

Snow chains cannot be fitted on 240/45 R/ZR 415 tyres mounted on 195 TR 415 wheels.

Technical modifications to the car

Any BMW service station will advise you on the practical value, legal position and factory attitude before modifications are undertaken; please quote the vehicle identification number and, where appropriate, the engine number.

Adjusting headlight beam setting for countries where traffic drives on the opposite side of the road

When crossing a border into a country with a different "rule of the road", that is to say where the traffic drives on the opposite side of the road:

Have the necessary adjustment work carried out beforehand by a BMW service station.

Re-registration abroad

Each car is supplied in accordance with the road vehicle use regulations of the country for which it is intended.

If the owner moves abroad and wishes to re-register the car locally, information should be obtained well in advance as to possible import and licensing restrictions or differences in the legal position.

Information can be obtained by telephone on (Germany) 89-31 84 01, if the model, vehicle identification number and date of first registration are quoted.

Roof rack *

A loaded roof rack can seriously affect the handling and steering characteristics of the car by displacing its centre of gravity. When loading items on to a roof rack, make sure that the permitted roof load, gross weight and axle loads are not exceeded.

To ensure the lowest possible roof load and optimum drag coefficient, use only a BMW-approved luggage or ski rack. When installing a roof rack, make sure that the mountings are attached securely to the roof and are located as far apart as possible.

The roof load must be evenly distributed and not too large in surface area. Always stow the heaviest items at the bottom.

Make sure that luggage on the roof is secured tightly and in the correct manner, so that there is no danger of it shifting or even falling off and endangering other road users during the journey.

Drive smoothly, avoiding jerky starts and sharp braking, and do not corner too fast. Luggage on the roof increases the car's frontal area, so that fuel consumption suffers and the load on the car's roof panel is increased.

You are recommended to remove the roof rack whenever it is not needed.

Note and comply with national regulations when loading your car.

Towing a trailer

Driving with a trailer always imposes more severe demands on both car and driver.

The trailer not only makes the car less manoeuvrable, but also affects its ability to climb hills and its acceleration, braking, ride and cornering behaviour.

The **trailer load limit** and the **towbar downthrust** or nose weight are shown in the section headed "Technical data"; the trailer load limit may also be stated in the car's licensing documents.

All BMW service stations will be able to inform you on the scope for boosting trailer load limits.

Towbar downthrust or nose weight is the vertical force exerted by the trailer on the ball hitch attached to the towing vehicle, and can be measured with the aid of bathroom scales.

In the Federal Republic of Germany, for instance, a minimum nose weight of 25 kg (55lb) is laid down by law.

Trailer loads in excess of 1600 kg (3527 lb) must have a nose weight of at least 50 kg (110 lb).

Without exceeding the limit, try to make full use of the maximum permissible nose weight if possible.

When **loading the trailer**, make sure that the additional load is stowed as low and as close to the axle as possible. A low centre of gravity on the trailer increases the safety of the complete outfit when on the move.

The gross trailer weight limit and the car's trailer load limit must both be complied with; note that the limit is represented by whichever of these values is reached first.

Since the nose weight is considered part of the car's payload, it must not cause the car's gross weight limit and rear axle load limit to be exceeded. The payload is reduced by the weight of the trailer coupling, and during trailer towing also by the nose weight of the trailer.

The trailer coupling* with detachable ball head should be of a pattern tested and approved by BMW; like the **trailer flashing turn indicator telltale** (required by law in certain countries including the Federal Republic of Germany), it should be correctly installed by a BMW service station.

After removing the detachable ball-ended towbar, it should be kept greased so that it can be installed again without difficulty.

Note on electrical system:

If a trailer (a caravan) is towed, higher power consumption must be expected. With a view to maintaining battery capacity, do not switch on electrical equipment for longer than necessary.

The rear lights, brake lights and rear fog lights on the trailer are protected by plug-type fuses in the trailer module, which is located behind the left-hand side trim in the luggage compartment.

Before acquiring a trailer it is advisable to obtain confirmation from the manufacturer or supplier of the **effective trailer weight** and the **permitted payload**.

The **suspension rates** of your BMW (both standard and sports suspension) ensure an optimum combination of road safety, ride comfort and good roadholding for the enthusiastic driver. They are equally suitable for towing a trailer at the standard load limit (not the increased weight limit), provided that this does not occur very much more often than during the annual holiday, and the driver's approach is modified to match the more arduous task of trailer towing.

If the trailer-towing hitch is factory-fitted, the car will have **trailer-towing suspension*** fitted as standard. These ratings compensate for the trailer weight and optimise road behaviour when driving without a trailer. If the trailer-towing hitch is fitted subsequently, we also recommend the installation of trailer-towing suspension.

Self-levelling rear suspension* is the ideal solution for frequent trailer towing. Unless the rear axle load is exceeded, the car always returns to its designed static ride height regardless of the load carried and whether the trailer is attached or not.

BMW has not tested or approved any other suspension devices sold by the automotive accessory trade.

Note:

If a trailer tow hitch is fitted, the effect of the regenerating rear bumper system will be reduced.

The installation of a **stabilizing device** is recommended, particularly with heavy trailers. BMW service stations can provide details.

If the standard **door mirror** is inadequate with the trailer attached, the law requires two outside mirrors to be fitted which enable the driver to see both rear corners of the trailer. Your BMW dealer can supply suitable mirrors, including types with adjustable arms or detachable versions for driving without the trailer.

In the interests of unobstructed traffic flow and maximum road safety, the **maximum gradient** permitted at sea level is restricted to 12% (1 in 8.3) or, with trailers of greater weight, to 8% (1 in 12.5).

Engine performance gradually declines at increasing altitudes. When driving in mountainous areas, it should therefore be remembered that the car's ability to pull away on steep inclines is adversely affected; in such driving conditions, the vehicle and trailer should not be driven with their maximum permitted payload.

Remember that the effect of the trailer brakes may be relatively limited, particularly when descending steep gradients. Select the next-lower gear in good time, and shift down as far as first gear (or automatic transmission selector lever position) if necessary to keep the outfit's speed low. Operate the foot brake only for limited periods at a time, to prevent fade.

Before starting a journey on which steep gradients are likely to be encountered, the serviceability of the trailer brakes should always be checked by an authorized service station.

Since the ABS prevents the wheels from locking, it may be appropriate to brake the car in such a way that the ABS comes into action. The braking distance required for the trailer combination, particularly on low-friction surfaces (icy roads), can be reduced significantly in this way.

If the car is fitted with trailer suspension, self-levelling suspension and the accompanying tyres, its gross weight limit and maximum rear-axle load for trailer operation may be increased in order to compensate for the reduction in payload due to the trailer's nose weight (only applies to vehicles registered in the Federal Republic of Germany, consult vehicle documents for details).

The **maximum speed limit when towing a trailer** in the Federal Republic of Germany is 80 km/h. The permissible trailer load limits have been chosen to ensure optimum vehicle stability at this speed. Even if higher speeds are permitted in other countries, do not exceed this speed for reasons of safety. Should the vehicle's progress be seriously disturbed at fairly high speeds, and the trailer begin to snake, the outfit must be stabilised immediately by applying the brakes.

Correct **tyre pressures** are of particular importance.

For the trailer, comply with the manufacturer's recommended tyre pressures.

Always check operation of the **trailer's rear lights** before starting the journey.

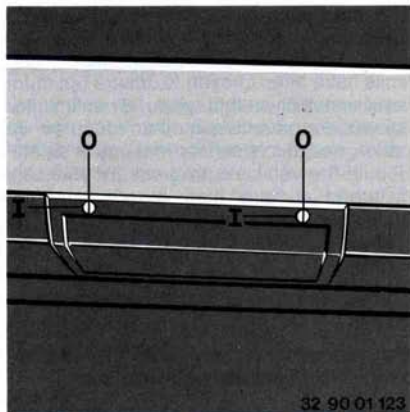

Trailer tow hitch cover flap

Insert a screwdriver or coin into the quick-acting coupling and turn:

- 0 = closed
- 1 = open

After removing the flap, the coupling head will be visible.

For attaching and detaching the ball joint coupling head, see separate instructions.

Antilock brake system (ABS)

BMW's unceasing efforts to improve its cars' active safety still further have led to the development of an antilock brake system (ABS).

Whenever a brake application is made, the ABS is required to satisfy two fundamental requirements:

- a) To maintain the car's stability on varying surfaces (asphalt, concrete, mud, wet roads, snow and ice)
- b) To ensure that the car can be steered and manoeuvred under these adverse conditions.

These requirements must, however, be seen in the light of certain unavoidable accompanying factors.

Even ABS is unable to prevent the natural laws of physics and motion from acting on the car. For instance, it cannot avoid the consequence of braking when there is insufficient distance remaining from the car in front, when cornering limit speeds are exceeded or if there is a risk of aquaplaning (tyres riding up on a cushion of surface water). It remains the driver's task to judge speeds and brake applications correctly in such conditions.

The fact that a car is equipped with ABS must never tempt the driver into taking risks which could affect occupant safety and that of other road users, despite the increased safety margins this system frequently provides.

Driving a car equipped with ABS

After the engine has been started, the yellow **ABS warning light** on the instrument panel will go out.

The system itself is then in working order but does not come into action until road speed exceeds approx. 8 km/h (5 mile/h). After this minimum control speed limit has been reached, the ABS prevents the wheels from locking when the driver applies the brakes. If the speed drops again below approx. 3 km/h (2 mile/h), the ABS ceases to operate, so that in theory the wheels could lock at the very end of a brake application, though in practice this is not critical at such a slow speed. The ABS regulating cycle is performed repeatedly within fractions of a second.

To inform the driver that his brake application has caused the ABS to come into action, a pulsating effect is noticed at the brake pedal, together with a characteristic chattering noise. This acts as a warning that grip between the tyre and the road is being lost (slippery surfaces), so that the driver can reduce speed accordingly.

ABS is capable of achieving the shortest possible braking distances in any given conditions (straight-line running or cornering, on smooth asphalt, ice, wet surfaces etc.).

The braking distance may be slightly longer on loose surfaces covering a firm base, such as snow or gravel, or if snow chains are fitted, since the locked wheels of a conventionally-braked car tend to build up a wedge of the loose material as they are forced through it.

However, the benefits of greater stability and the fact that the car can be steered more than outweigh this occasional slight drawback.

In order to keep it fully functional, no modifications may be made to the antilock braking system. Any work on the ABS must only be carried out by authorised, skilled personnel.

Proper functioning may be impaired if different sizes of tyre are fitted (e.g. winter tyres and the spare wheel. Change back as soon as possible.)

The yellow ABS warning light on the instrument panel comes on to indicate any malfunction. The brake system then operates conventionally and with precisely the same standards of performance as on cars not equipped with ABS.

In order to prevent any multiple faults from impairing the brake system, the necessary repair work should be carried out at the next possible opportunity.

Automatic Stability Control (ASC) * or Automatic Stability Control + Traction (ASC+T) *

As a means of ensuring improved dynamic stability, particularly when accelerating and cornering, BMW has extended its ABS system to include ASC/ASC+T, which prevents the driven wheels from spinning even if driving and road conditions are unfavourable.

The traction and vehicle locating force which the tyres can transmit to the road surface depends to a marked degree on driving style (use of the engine's power potential) and road surface condition (wet, slippery etc.). The limits imposed by these factors should not be exceeded, or else the car may become difficult to keep under control.

ASC/ASC+T is a highly responsive system which uses the ABS wheel sensors to detect wheel rotating speeds, and reduces engine power if these speeds differ.

This continuous wheelslip monitoring system identifies the risk of a wheel spinning if it is called upon to transmit too much power, and reduces engine power output (ASC+T: the driven wheels are also braked if necessary) until reliable tyre grip is assured.

Although the driver may find this automatic reduction of engine power difficult to accept, there is no denying that when a difficult situation arises (poor road surface, sharp corner etc), the instant response of the ASC/ASC+T system is the only way of ensuring optimum traction and acceleration.

However, even a car fitted with ASC/ASC+T is subject to the normal physical laws, so that the driver must still avoid speeds at which tyre grip cannot be maintained or lateral forces become too high. It would be irresponsible to misuse the additional safety margin which ASC/ASC+T can provide in certain circumstances to drive at the very limit of the car's performance when this would constitute a self-evident safety risk.

The ASC/ASC+T system can be switched off and the car's driveline allowed to operate conventionally. In order to boost traction, it is also advisable to switch it off when trying to rock the car out of deep snow or a soft surface (see "Winter operation") and when snow chains are fitted.

If not all the tyres are of the same pattern, ASC/ASC+T may react over-sensitively. Only fit tyres of the same make and tread pattern.

Multi-disc limited-slip differential*

In very unfavourable driving conditions, the conventional form of differential may be unable to transmit torque to the road without wheelslip occurring. The limited-slip differential (25% locking action) greatly reduces the tendency for one driven wheel to spin.

In practice, this means improved traction when pulling away, accelerating (when road conditions are unfavourable as already described) and cornering at speed in poor driving conditions.

A car also tends to spin round its vertical axis (centre of gravity) when the power output is high or when load reversals occur on surfaces with a varying degree of grip. A good deal of skill is required to control such skidding or spinning, particularly when driving in a highly enthusiastic manner.

The limited-slip differential has the advantage of operating automatically when needed; it does not have to be engaged and disengaged by the driver.

Care of the car

The car's high-quality paint finish is chosen not only to appeal to the owner's personal colour preferences, but also to provide maximum body protection. It consists of **several layers** for reliable corrosion-proofing; the body cavities are not only primer-coated by cathaphoretic dipping, but also treated with materials specially developed for this purpose in lengthy tests. The entire floor pan is given a sprayed-on, resilient PVC coating followed by complete wax-based under-sealing.

Regular care and maintenance make a big contribution to safety and to your car's resale value.

A large number of **environmental influences** can affect the car's paintwork, some of them purely local in origin. They govern the amount of care the paintwork needs and how often it should be attended to.

Road dust and dirt, tar stains, dead insects, animal excretions (high level of alkali formation) as well as tree and plant materials (resin, pollen) all contain chemicals which, if allowed to remain on the car for any length of time, can damage the paintwork by causing patches, blisters, corrosion, flaking of the top coat etc.

In **industrial areas**, the horizontal panels of the body in particular may suffer from deposits of fly ash, lime, oily soot or substances containing sulphur dioxide ("acid rain"), as well as other less easily identified deposits. Only regular care of the paintwork can avoid damage in such circumstances.

In **coastal regions** the high salt content and humidity of the atmosphere greatly increase the risk of body panel corrosion.

In **tropical climates**, ultra-violet radiation from the sun is very strong, the air is often very humid and temperatures can exceed 40°C (104°F) in the shade. Light paint finishes may heat up to 80°C (176°F) and darker colours as high as 120°C (248°F). Prolonged exposure could cause the paint finish to develop cracks, particularly on horizontal surfaces.

In the event of **mechanical damage** caused by sand, road salt, grit etc., the paint surface may be damaged or penetrated, and corrosion may then spread across the panel under the paint.

Since the car's paintwork is exposed to so many potential environmental hazards, automobile manufacturers and paint suppliers are constantly working on further improvements to the strength and durability of modern paints.

The composition of the paints used by BMW and the manner in which they are applied are in accordance with the very latest standards in this specialised area.

If you choose to look after the car yourself, all BMW service stations can supply tried and tested Original BMW care agents.

Care of paintwork

To protect the car from the start against gradual deterioration of the paintwork in areas of high atmospheric pollution or where natural substances could damage the paint finish (industrial zones, railways, sap and resin from trees, pollen, bird droppings), it is advisable to **wash the car once a week**. In severe cases, wash the car whenever the paint finish is seen to be dirty or contaminated.

Remove spilled fuel, oil, grease or brake fluid **at once**, as they can attack the paint and change its colour.

Bird droppings should also be **removed without delay**, or they will damage the paintwork.

A new BMW can be put through an automatic car wash, or washed by hand, as soon as it is used on the road.

In automatic car washes, make sure that any projecting body elements (e.g. spoilers) cannot become damaged.

If necessary, point them out to the person in charge of the car wash before using it.

Dead insects should be soaked and wiped off **before** the main car wash.

Washing the car

Do not wash the car if the engine compartment lid is still hot, or if the car has been standing in strong sunlight, or else patches may form on the paint surface.

When using an automatic car wash, try to choose one without excessive brush pressure and with an ample supply of rinsing water. Most modern car washes satisfy these requirements. However, the areas not fully reached by the automatic car wash – door sills, panel folds and seams on doors and lids etc. – should be cleaned by hand.

During the cold season of the year in particular it is advisable for the car to be washed more frequently, since heavy dirt deposits and salt from wet roads are more difficult to remove and will damage the entire car if left on too long.

If the car is **washed by hand**, first soften the dirt deposits on the paint with a fine water spray, and rinse them off. Do not spray water directly into the air inlets or outlets of the heating/ventilation system.

After this, wash the upper part of the body with a sponge, washleather glove or similar, using plenty of no more than lukewarm water, and starting with the roof. Rinse out the sponge frequently.

Wash the lower part of the body and the wheels last of all, if possible keeping a separate sponge just for these areas.

After washing, rinse the car down again thoroughly with the hose and dry it with a clean chamois leather to prevent discoloured patches where the water was not removed.

To protect the paintwork, a paint-care product* can be added to the water used for washing the car.

If washing with water alone is insufficient, a car shampoo or similar cleanser* which restores the fats content of the paintwork can be used, in the concentration stated on the pack. After this, rinse down with plenty of water.

Note: after washing, the car's brakes may be wet and therefore less effective in action. Apply them briefly if the car is driven immediately afterwards, to dry the discs.

Any local dirt patches or other contamination of the paint surface can best be seen after the car has been washed. Remove them as soon as possible with a clean cloth or wadding soaked in alcohol spirit or cleaning-grade petrol (gasoline). Eliminate tar stains with a special tar remover*.

Polish the paintwork at these points to restore its appearance and protect it.

Please use only **paint care products** containing carnauba or synthetic waxes.

It is quite easy to decide when the car's paintwork needs polishing or preservative treatment: water no longer forms large round droplets on the painted surfaces. Depending on use of the car, this may arise after some 3 to 4 months. Do not fail to carry out the necessary protective treatment as soon as it becomes necessary.

If the paintwork tends to lose its high gloss as a result of insufficient care, a suitable **polish*** must be applied. **Paint cleaner*** is needed if the finish is already matt or weathered. An abrasive **cutting agent** or **paint restorer*** should only be used in severe or obstinate cases. Remember that all polishes, cleaners and paint restorers act by removing a layer of paint to expose paint which is still in good condition. Only if the resulting new paint surface is most carefully protected will the overall brilliance of your car's paintwork be regained.

After care of the car's paintwork, remove traces of the products used from the windows with a suitable glass cleaner*.

* Obtainable from BMW service stations

Minor paint damage can be touched in with a BMW paint spray aerosol*, a BMW paint stick* or BMW paint film. The correct colour designation is stated on a label close to the maker's plate, and also on the first page of the Service Booklet.

Damage caused by flying stones, scratches etc. must be touched in **without delay**, to prevent rust from forming.

If damaged areas of paintwork have already started to rust, use a wire brush to clean them up, and apply a rust converter (protect the eyes and skin). Allow a few minutes for it to take effect, then rinse off with water and dry thoroughly. Apply the primer and allow to dry, then apply the top coat. After a few days, polish the repaired area and apply a paint preservative.

More extensive paint damage should be professionally repaired by the BMW service station, which uses only genuine BMW-approved materials in accordance with the manufacturer's instructions.

Important note:

If a tarpaulin or similar cover is used to protect the car against the weather, moisture condensate may collect, particularly in the case of plastic sheet, and cause the plasticisers to diffuse out of the paint. There is also a risk of scratching the paint surface. It is far better to protect your BMW against ultra-violet rays from bright sunlight and against rainfall etc. by giving it the full body care treatment described here. Ideally, in countries where the sun is extremely hot and powerful, a canvas sunsheet should be stretched 50 to 80 cm (1–2 ft) above the car.

Annual cleaning and protection or treatment of the engine, engine compartment, underbody, axles and other mechanical assemblies can be carried out with special equipment by a BMW service station. This not only **reduces the risk of serious corrosion** to a minimum, but avoids short-circuits or current leakages and reveals other leaks before they become too severe. This treatment is particularly important at the end of the winter season.

Chromium-plated and polished metal parts – bumpers, trim strips, wheel trims etc. – should be cleaned regularly with water to which a car shampoo* can be added if required. Do not neglect this treatment in winter if salt is spread on the roads.

Alloy wheels should be treated with a special wheel-rim cleanser*, particularly during the cold season. Do not use aggressive-action products containing acids, strong alkalis or abrasives. Alloy wheels should not be cleaned with a steam jet at a temperature higher than 60°C (140°F).

The **inside surfaces of windows (and mirror glasses)** can be cleaned and smearing avoided with a special glass cleaner*. Never clean mirror glasses with polishing pastes or abrasive (quartz) cleansers.

Plastic components, leatherette upholstery, roof linings, light glasses and items sprayed matt black should be cleaned with water to which a car shampoo* may be added. Do not allow the roof lining to become wet right through. If necessary, treat plastic components with a suitable cleanser for synthetic materials*. Never use solvents such as nitro thinners, cold cleaning agents, fuel etc.

Rubber components should only be cleaned with water or treated with a rubber cleanser* or silicone spray*.

Clean the **windscreen wiper blades** with soapy water. The wiper blades should be renewed twice a year, before and after the winter season.

Seat belts should only be cleaned with a weak soap and water solution, without removing them from the car. Never attempt chemical or dry cleaning, or the belt fabric may be damaged.

Automatic-reel seat belts should never be allowed to retract while still wet. Dirt on the belts could prevent them from retracting correctly, thus constituting a safety risk.

Floor mats and carpets* can be cleaned with an interior cleanser* if very dirty.

Floor mats can be removed for more thorough cleaning of the car's interior.

* Obtainable from BMW service stations

Care of upholstery fabrics

If certain areas of the seats acquire an unwanted gloss after heavy use as a result of heat, friction and moisture, they should be brushed "against the pile" with a slightly moistened brush.

The pile of velour material tends to lie flat in use: as with many furnishing fabrics and clothing materials, this is unavoidable and does not detract from its quality.

Fluff and loose threads or abraded leather particles on the upholstery are best removed with a suitable fluff brush* or burr-pile brush*. Clean off stains or large-area marks at once with lukewarm water, car-interior cleaner, stain remover* or cleaning-grade fuel. Afterwards, brush the fabric to restore its pile.

Seat upholstery fabrics can acquire a **static electrical charge**, particularly when atmospheric humidity is low. Persons touching metal parts of the body **after** leaving the car may then receive an unpleasant but harmless electric shock. Remember to touch an exposed metal part of the car **while getting out**: this will disperse the electric charge without its being noticed.

Antistatic products which largely prevent the build-up of static electricity can be applied if desired.

If the car is parked for a long time in bright sunlight, it is advisable to cover the seats to prevent the colours from fading.

Care of leather

The **upholstery leather*** used in BMW cars is a high-grade natural product treated by the latest processes. If carefully looked after, it will retain its high quality for many years.

Like all natural products, however, due consideration must be given to its properties, to certain limitations in use and to the special care which leather needs.

Regular cleaning and care are essential, since dust and road dirt penetrate the pores and creases, and cause the surface to wear away and become brittle.

If the car is parked for a long time in bright sunlight, it is advisable to cover leather surfaces to prevent the colours from fading, or cover the windows.

Moisten a cotton or woollen cloth slightly with water and clean the leather surface without allowing the seams to become wet through. After drying, the leather should be rubbed down with a soft, clean cloth.

Very dirty areas on leather upholstery can be cleaned with a mild detergent (as sold for woollens) containing no brightening agents. Use 2 tablespoons to one litre (1³/₄ Imp. pints) of water. Dab oil or grease spots carefully with cleaning-grade fuel but do not rub.

To maintain the condition of the (treated) leather after cleaning, and avoid the build-up of a static electrical charge, apply a **leather care agent***. Shake well and apply a thin coating with a soft cloth. Allow to penetrate and dry, then rub with a clean, soft cloth.

It is advisable to repeat this treatment every 6 months if the leather is exposed to normal use.

* Obtainable from BMW service stations

Water buffalo leather*

Use only a special leather spray* for regular care, according to the manufacturer's instructions.

Wipe off drops of water immediately, and try to avoid wetting the surface severely (soaking wet clothing, when cleaning etc).

To remove severe dirt marks, use a mild detergent without brightening agent (2 tablespoons to 1 litre of water).

Water buffalo leather is left in its natural state and may therefore exhibit areas of slightly varying colour. Natural features such as scars caused by scratches and insect bites, folds in the animal's skin etc. are typical of this material, which acquires a certain patina in use. When new, water buffalo leather may mark light-coloured clothing slightly if moisture is present.

Warning:

Keep cleaning products out of the reach of children. Many products are toxic or flammable, and therefore hazardous in use.

Before using any such product, study and comply with the instructions supplied with it, and note any warnings or precautions stated on the pack.

When cleaning the car's interior, always open a door or window. Never use products or solvents not specified for cleaning the car.

* Obtainable from BMW service stations

Engine data, fuel consumption

		BMW 730i 6-cylinder		BMW 730i 8-cylinder	
Displacement	cm ³	2986		2997	
Number of cylinders		6		8	
Max. output	kW	138		160	
	bhp	188		218	
– at engine speed	1/min	5800		5800	
Max. torque	Nm	260		290	
– at engine speed	1/min	4000		4500	
Compression ratio	:1	9.0		10.5	
Stroke/bore	mm	80/89		67.6/84	
Mixture preparation			Digital Motor Electronics		
Fuel consumption (DIN 70 030/1 ECE standard test method)		5-speed gearbox	Automatic	5-speed gearbox	Automatic
At 90 km/h (56 mile/h)	l/100 km (Imp. mile/gal)	7.6/7.6*	7.9/7.9*	8.3	7.7
At 120 km/h (90 mile/h)	l/100 km (Imp. mile/gal)	37.2/37.2*	35.8/35.8*	34.0	36.7
Urban driving cycle	l/100 km (Imp. mile/gal)	9.4/9.3*	9.8/9.7*	10.2	9.5
	l/100 km (Imp. mile/gal)	30.1/30.4*	28.8/29.1*	27.7	29.7
	l/100 km (Imp. mile/gal)	16.3/15.6*	17.3/17.1*	14.9	15.6
Average	l/100 km (Imp. mile/gal)	17.3/18.1*	16.3/16.5*	19.0	18.1
	l/100 km (Imp. mile/gal)	11.1/10.8*	11.7/11.6*	11.1	10.9
		25.5/26.2*	24.1/24.4	25.5	25.9

* without catalytic converter

Engine data, fuel consumption

		BMW 740i/iL	BMW 750i/iL	
Displacement	cm ³	3982	4988	
Number of cylinders		8	12	
Max. output	kW	210	220	
	bhp	286	300	
– at engine speed	1/min	5800	5200	
Max. torque	Nm	400	450	
– at engine speed	1/min	4500	4100	
Compression ratio	:1	10.0	8.8	
Stroke/bore	mm	80/89	75/84	
Mixture preparation		Digital Motor Electronics		
Fuel consumption (DIN 70 030/1 ECE standard test method)			BMW 750i	BMW 750iL
At 90 km/h	l/100 km	8.2	8.8/8.9*	8.8/8.9*
(56 mile/h)	(Imp. mile/gal)	34.4	32.1/31.7*	32.1/31.7*
At 120 km/h	l/100 km	9.9	10.9/11.1*	10.9/11.1*
(90 mile/h)	(Imp. mile/gal)	28.5	25.9/25.4*	25.9/25.4*
Urban driving cycle	l/100 km	17.5	19.8/19.8*	20.8/20.8*
	(Imp. mile/gal)	16.1	14.3/14.3*	13.6/13.6*
Average	l/100 km	11.9	13.2/13.3*	13.5/13.6*
	(Imp. mile/gal)	23.7	21.4/21.2*	20.9/20.8*

* without catalytic converter

Dimensions

		BMW 730i 6-cylinder	BMW 730i 8-cylinder	BMW 740i	BMW 750i	BMW 740iL	BMW 750iL
Length	mm (in)		4910 (193.3)			5024 (197.8)	
Width	mm (in)			1845 (72.6)			
Height	mm (in)		1411 (55.6)			1400 (55.1)	
Wheelbase	mm (in)		2833 (111.5)			2947 (116.02)	
Front overhang	mm (in)			887 (34.9)			
Rear overhang	mm (in)			1190 (46.9)			
Front track	mm (in)			1530 (60.2)			
Rear track	mm (in)			1558 (61.3)			
Min. turning circle (wheels)	m		10.8 (35 ft 5 in)			11.2 (36 ft 9 in)	
Min. turning circle (overall)	m		11.6 (38 ft 1 in)			12.0 (39 ft 4 in)	

Weights

		BMW 730i 6-cylinder	BMW 730i 8-cylinder	BMW 740i	BMW 750i	BMW 740iL	BMW 750iL
Unladen weight (ready to drive, full tank, without special equipment)	kg	1600	1700	–	–	–	–
	(lb)	(3527)	(3748)	–	–	–	–
	– with automatic transmission	kg 1600 (lb) (3527)	1730 (3813)	1790 (3946)	1830 (4034)	1830 (4034)	1860 (4101)
Gross weight limit	kg	2130	2220	–	–	–	–
	(lb)	(4696)	(4894)	–	–	–	–
	– with automatic transmission	kg 2150 (lb) (4740)	2250 (4960)	2310 (5093)	2350 (5181)	2350 (5181)	2380 (5247)
Front axle load limit	kg	1025	1065	1100	1110	1110	1130
	(lb)	(2260)	(2348)	(2426)	(2447)	(2447)	(2491)
Rear axle load limit	kg	1190	1240	1255	1280	1280	1280
	(lb)	(2623)	(2734)	(2767)	(2822)	(2822)	(2822)
Trailer load limits (specified by manufacturer or as laid down by law in Germany) ¹⁾							
unbraked				750 kg (1653 lb)			
braked, max. gradient 12%				1600 kg (3527 lb)			
braked, max. gradient 8 %				2000 kg (4409 lb) ²⁾			
Max. towbar downthrust (nose weight)		50 kg (110 lb); with BMW self-levelling suspension or BMW trailer towing suspension rates, 75 kg (165 lb)					
Max. roof load (do not exceed max. axle loads or gross weight limit when carrying loads on roof)		100 kg (220 lb)					
Luggage capacity acc. to VDA method		500 litres (17.7 cu. ft.)					

Different values may apply to national-market specifications and special models. Please always follow the data in the vehicle papers or on the manufacturer's type plate.

¹⁾ Please consult a BMW service station regarding higher trailer load limits. These values may differ on certain national versions.

²⁾ Only in conjunction with BMW self-levelling suspension or BMW trailer-towing suspension. Self-levelling suspension is supplied as standard on certain models; the factory-fitted trailer towing hitch includes trailer-towing suspension on models without self-levelling suspension.

Important – vehicles with self-levelling suspension:

The luggage compartment may be loaded to a max. of 120 kg (260 lb), however, the gross weight limit and the rear axle load limit should not be exceeded.

Performance

			BMW 730i 6-cylinder	BMW 730i 8-cylinder	BMW 740i/iL	BMW 750i/iL
Top speed	km/h	(mile/h)	222 (138)	233 (145)	–	–
with automatic transmission			222 (138)	230 (143)	240 (149) governed	250 (155) governed
Acceleration	km/h	(mile/h)	s	s	s	s
	0 – 50	0 – 31	2.9	2.7	3.1	3.2
	0 – 80	0 – 50	6.3	5.8	5.3	5.3
	0 – 100	0 – 62	9.3/10.6*	8.5/9.3*	7.4	7.4
	0 – 120	0 – 75	12.8	11.6	9.7	9.8
	80 – 120 km/h (50 – 75 mile/h) in 4th gear		10.9	9.4	–	–
Standing-start kilometre			30.1/31.9*	28.9/29.9*	27.4	27.3

* With automatic transmission

Note: engine and road performance are measured according to the appropriate DIN standard (with the vehicle to standard equipment specification). Permissible deviations are also taken into account.

Additional equipment or optional extras can have a significant effect on consumption and performance figures, since the car's weight and drag coefficient are usually altered (roof rack, wider tyres, additional mirrors etc.).

Technical data**Gear ratios**

	BMW 730i 6-cylinder 5-speed gearbox	BMW 730i 6-cylinder, 750i/iL Automatic transmission
1st	3.83	2.48
2nd	2.20	1.48
3rd	1.40	1.00
4th	1.00	0.73
5th	0.81	—
Reverse	3.46	2.09

	BMW 730i 8-cylinder 5-speed gearbox	Autom. trans.	BMW 740i/iL Autom. trans.
1st	4.20	3.67	3.55
2nd	2.49	2.00	2.24
3rd	1.66	1.41	1.54
4th	1.24	1.00	1.00
5th	1.00	0.74	0.79
Reverse	3.89	4.10	3.68

Electrical system

Battery 12 V, 85 Amp/h

2nd battery* in luggage compartment
12 V, 25 Amp/h

Firing order

BMW 730i 6-cylinder 1-5-3-6-2-4
BMW 730i 8-cylinder, 740i/iL
1-5-4-8-6-3-7-2

BMW 750i/iL
1-7-5-11-3-9-6-12-2-8-4-10

Ignition timing

On cars equipped with Digital Motor Electronics, ignition timing is pre-programmed and cannot be adjusted.

Alternator

BMW 730i 6-cylinder 90 A, 1260 W
BMW 730i 8-cylinder 100 A, 1400 W
BMW 730iA 8-cylinder,
BMW 740i/iL, 750i/iL 140 A, 1960 W

2nd alternator* 33 A, 460 W
with built-in voltage regulator

Technical data**Gear ratios**

	BMW 730i 6-cylinder	BMW 730i 6-cylinder, 750i/iL Automatic transmission
1st	3.83	2.48
2nd	2.20	1.48
3rd	1.40	1.00
4th	1.00	0.73
5th	0.81	-
Reverse	3.46	2.09

	BMW 730i 8-cylinder 5-speed gearbox	Autom. trans.	BMW 740i/iL Autom. trans.
1st	4.20	3.67	3.55
2nd	2.49	2.00	2.24
3rd	1.66	1.41	1.54
4th	1.24	1.00	1.00
5th	1.00	0.74	0.79
Reverse	3.89	4.10	3.68

Electrical system

Battery 12 V, 85 Amp/h
2nd battery* in luggage compartment
12 V, 25 Amp/h

Firing order

BMW 730i 6-cylinder 1-5-3-6-2-4
BMW 730i 8-cylinder, 740i/iL
1-5-4-8-6-3-7-2
BMW 750i/iL
1-7-5-11-3-9-6-12-2-8-4-10

Ignition timing

On cars equipped with Digital Motor Electronics, ignition timing is pre-programmed and cannot be adjusted.

Alternator

BMW 730i 6-cylinder 90 A, 1260 W
BMW 730i 8-cylinder 100 A, 1400 W
BMW 730iA 8-cylinder,
BMW 740i/iL, 750i/iL 140 A, 1960 W
2nd alternator* 33 A, 460 W
with built-in voltage regulator

Index

ABS 112
Accelera
Acid leve
Adaptive
Aerial 67
Airbag 1
Air condi
Air condi
Alarm sy
Alternatc
Antifreez
Antilock
– warnin
Armrest
ASC 47,
ASC+T 4
Ashtrays
Automat
Automat
Automat
Automat
Automat
Automat
Automat
(ASC-
Automat
– oil con
– ratios
– selectc
Axle loa

Battery &
Battery &
Battery c
Body car
Body din
Body ov
Body pro
Brake ar

Index
ABS 112
Acceleration values 124
Acid level 85
Adaptive transmission control (AGS) 34
Aerial 67
Airbag 17
Air conditioning 38
Air conditioning, rear seat area 54
Alarm system 48
Alternator 125
Antifreeze 100
Antilock brake system 112
– warning light 26
Armrest 45
ASC 47, 113
ASC+T 47, 113
Ashtrays 41
Automatic air conditioning 38
Automatic Recirculated-Air Control 38
Automatic seat belts 16, 117
Automatic “soft-close” system 8, 57
Automatic Stability Control 47, 113
Automatic Stability Control + Traction
(ASC+T) 47, 113
Automatic transmission 32
– oil content 130
– ratios 125
– selector lever position indicator 32
Axle load limits 123

Battery 85, 88, 125
Battery acid level 85
Battery charge telltale 27
Body cavity sealing 115
Body dimensions 122
Body overhang 122
Body protection treatment 117
Brake and steering hydraulics warning
lamp 26, 93

Brake fluid 81
Brake fluid 81, 93
Brake light 28
Brake lights 96
Brake linings 93
Brake pressure 93
Brakes 71, 93, 103
Brakes, bedding down 71
Bulb changing 94

Car radio 56, 67
Car telephone 68
Caravan towing 110
Care of car 115
Catalytic converter 70
Central locking system 7
Check Control 28
Check Control 29
Childproof door locks 9
Child restraint systems 16
Chromium, care of 117
Cigarette lighter 42
Clock 41, 50, see also Computer, on-board
Clock, digital 50, see also Computer,
on-board
Cold starting 69, 72
Cold weather operation 100
Compression ratio 120
Computer, on-board 58
Convenience circuit for electric window
and electric sunroof 8, 44
Coolant 100
Coolant level, checking 82
Coolant level 82
Coolant tank 82
Coolant temperature 25
Coolant temperature 25
Coolant temperature gauge 25
Coolbox 55
Cooling system 82, 100
Cooling system capacity 130

Corrosion protection 116
Cruise control 46

Defrosting windows 36
Dimensions 122
Dipped beams 26, 94
Dipstick 77
Disc brakes 103
Displacement (engine) 120
Door lock heating 8
Door locks 7
Door mirrors 18
Driver's door lock heating 8
Driving hints 72, 101, 103
Dust caps (tyre valves) 107

Economy 69
Electrical system 125
Electronic Damping Control (EDC) 47
Electronic engine output control (EML) 26
Energy Control 24
Engine capacity 120
Engine compartment lid 73
Engine compartment light 73, 98
Engine compartment, principal
components 74
Engine data 120
Engine oil content 130
Engine oil grades 79
Engine oil level, checking 77
Engine oil low 77
Engine oil pressure 28, 77
Engine oil pressure telltale 26
Engine performance 120
Engine power output 120
Engine specifications 120
Engine torque 120

Filling capacities 130
Final drive oil content 130
Fire extinguisher 90

- Firing order 125
- First aid box 87
- Flashing turn indicators 22
- Flat battery 88
- Fog light, rear 30, 96
- Fog lights, front 30, 95
 - cleaning system 23, 83
- Footwell lights 41, 97
- Front seat adjustment 12
- Front seat adjustment, electrical 13
- Fuel consumption 69, 72, 120
- Fuel consumption indicator 24
- Fuel economy 69
- Fuel filler flap 4, 8
- Fuel gauge 25
- Fuel grades 4
- Fuel tank capacity 130
- Fuel telltale lamp 25
- Fuses 87

- Gearbox (manual) 31
- Gearbox gate pattern 31
- Gearbox oil capacity 130
- Gearbox ratios 125
- Glove box 42
- Gross weight limit 123

- Hand lamp, rechargeable 43
- Handbrake 31, 71
- Hazard warning flashers 30
- Head restraints 12, 14
- Headlight and side light switch 22
- Headlight beam throw adjustment 22
- Headlight cleaning system 23
- Headlight cleaning system tank 83
- Headlight flasher 22
- Headlights 94, 109
- Heated rear window 28
- Heating 36
- Heater/ventilation, independent 51
- Height 122

- High beam headlights 22, 94
- High-Line rear seat area specification 53
- Horn 23

- Ignition/starter switch 20
- Ignition timing 122
- Individual air conditioning system
 - for rear 54
- Infra-red remote control 10
- Instrument cluster 21
- Instrument lighting 22
- Instruments 21
- Intensive cleaning system 23
- Intensive cleaning system tank 83
- Interior lights 41, 98
- Interior mirror 19

- Jack 90

- Keys 7
- Kickdown 33

- Laying up out of use 99
- Leather care 118
- Length 122
- Licence plate lights 97
- Light switch 22
- Limited-slip differential 114
- Locks 99, see also Door locks
- Low beam headlights 26, 94
- Luggage compartment 8
- Luggage compartment capacity 123
- Luggage compartment light 9, 98
- Lumbar support 14

- Main beam 26, 94
- Maker's plate 74
- Make-up mirror 19
- Memory for seat/mirror adjustment 13
- Microfilter 40
- Minor repairs 117

- Mirrors 18
- Modifications 108

- Number plate lights 97

- Octane number 4
- Oil additives 78
- Oil content 130
- Oil grades 79, 130
- Oil level, checking 77
- Oil level sensor** 29
- Oil pressure telltale 26
- On-board computer 58
- Outside temperature display and digital
 - clock 50
- Overhang 122

- Paintwork, care of 100, 115
- Paintwork damage 117
- Park Distance Control (PDC) 66
- Parking lights 22, 94
- P.A.S. fluid** 29, 80
- Performance, road 124
- Performance, engine 120
- Power output 120
- Power steering 80, 90, 93
 - oil level check 80
- Power-driven closing system 8, 57
- Punctures 90

- Radial ply tyres 105, 107
- Radiator cap 82
- Radiator header tank 82
- Radio 56, 67
- Radio aerial 67
- Reading lights 41, 98
- Rear fog light 30, 96
- Rear lights 96
- Refuelling 4
- Remote control 10
- Re-registration abroad 100

- Reservoir
- Reversing
- Revolutions
- Roof load
- Roof rack
- Rubber c
- Running

- Seat adju
- Seat adju
- Seat belt
- Seat hea
- Seat/mirr
- Selector
- Self-level**
- Self-level
- Service li
- Servotror
- Side light
- Ski bag f
- Sliding/tit
- Snow ch
- Spark plu
- Spare wt
- Specifica
- Speedon
- Speed cr
- Sports se
- Sports su
- Starting :
- Starting i
- Starting v
- Steering
- Steering
- Steering electri
- Stop lig
- Storage :
- Sun blind

Reservoir for hydraulic clutch fluid 82
 Reversing lights 31, 96
 Revolution counter 24
 Roof load limit 123
 Roof rack 109
 Rubber components 100, 117
 Running in 71

Seat adjustment 12
 Seat adjustment, electric 13
 Seat belts 16, 117
 Seat heating 43, 55
 Seat/mirror memory 13
 Selector lever position indicator 32
Self-levelling suspension 28, 93
 Self-levelling suspension, oil level 80
 Service Indicator 25
 Servotronic 93
 Side lights 22, 94
 Ski bag 64
 Sliding/tilt roof 44, 94
 Snow chains 101, 102, 108
 Spark plugs 132
 Spare wheel 90
 Specifications 120
 Speedometer 21
 Speed control 46
 Sports seat 13
 Sports suspension 110
 Starting aids 88
 Starting the engine 69
 Starting with flat battery 88
 Steering lock 20
 Steering wheel reach adjustment 14
 Steering wheel reach adjustment,
 electric 15
 Stop lights 96
 Storage compartments 43
 Sun blind 45, 57

Sun visors 19

Technical data 120
 Technical modifications 108
 Telephone system 68
 Telltale lamps 26
 Thermometer, coolant 25
 Thiefproofing device 7, 10
 Thiefproof wheel studs 92
 Time switch 51
 Toolkit 90
 Top speed 124
 Torch, rechargeable 43
 Torque 120
 Tow starting 89
 Towbar downthrust 123
 Towing a trailer 110
 Towing away 89
 Towing eyes 89
 Track 122
 Trailer load 123
 Trailer nose weight 123
 Trailer towing 110
Trans. program 33
 Triangle, warning 90
 Trip distance recorder 24
 Turn indicator repeater 22, 96
 Turn indicators 22
 Turning circle 122
 Type plate 74
 Tyre pressures 131
 Tyre repairs 92
 Tyre sizes 108
 Tyre tread 105
 Tyre valve caps 107
 Tyres 105
 Tyres, fitting new 106

Underseal 117

V-belts 131
 Vehicle identification number 74
 Ventilation 36

Warning lamps 26
 Warning lamp for brake and steering
 hydraulics 26, 93
 Warning triangle 90
 Weights 123
 Wheel-changing 90
 Wheel chock 90
 Wheel sizes 108
 Wheel stud wrench 90
 Wheel studs, lockable 92
 Wheelbase 122
 Wheels, interchanging 106
 Width 122
 Window lifts, electric 44
 Windscreen wash/wipe 23
 Windscreen washer fluid tank 83
 Windscreen washer jets 85
 Windscreen wipers 23
 Windscreen wiper blades 93, 117
 Winter operation 100
 Winter tyres 107

Xenon lights 22, 95

Note: **items in bold type** are Check Control displays accompanied by the "OWNER'S HANDBOOK" reminder.

Filling capacities	Litres (Imp. units)	Notes
Fuel tank	90 or 102* (19.8 or 22.4 gal)	Fuel grades: see Page 4
Windscreen washer	app. 3.0 (5.3 pints) – BMW 730i 6-cylinder app. 2.5 (4.4 pints) – BMW 730i 8-cylinder, 740i/iL app. 6.5 (11.4 pints) – BMW 750 i/iL	For details, see Page 83
When combined with headlight and fog light cleaning system	app. 7.5 (13.2 pints) – BMW 730i 8-cylinder, 740i/iL app. 9.0 (15.8 pints) – BMW 750i/iL	
Headlight and fog light cleaning system	app. 8.0 (14.1 pints) – BMW 730i 6-cylinder	
Intensive windscreen cleaner	app. 1.0 (1.8 pints)	
Cooling system including heater circuit	12.0 (21.1 pints) – BMW 730i 6-cylinder 12.5 (22.0 pints) – BMW 730i 8-cylinder, 740i/iL 13.0 (22.9 pints) – BMW 750i/iL	For details, see Page 82
Engine oil with filter renewal	5.75 (10.1 pints) – BMW 730i 6-cylinder 7.5 (13.2 pints) – BMW 730i 8-cylinder, 740i/iL, 750i/iL	Brand-name HD oil for spark-ignition engines; see Page 79 for grades
Manual gearbox	1.25 (2.2 pints)	ATF ¹⁾
Automatic transmission	3.0 (5.3 pints) – BMW 730i 6- and 8-cylinder –* – BMW 740i/iL 3.5 (6.2 pints) – BMW 750i/iL * Lifetime oil filling, no oil changes required	ATF ¹⁾ Except during routine Inspections, no oil (ATF) level check is scheduled, to avoid the risk of incorrect filling. In unusual circumstances, please consult your BMW service station.
Final drive (rear axle)	1.7 (3.0 pints) – BMW 730i 6- and 8-cylinder 1.9 (3.3 pints) – BMW 740i/iL, 750i/iL	Brand-name hypoid gear oil ¹⁾

¹⁾ BMW service stations know the correct grades

V-belts

BMW 730i 6-cylinder

Alternator and coolant pump

12.5 × 1055

Hydraulic power steering pump

9.5 × 865

Air conditioning compressor

12.5 × 835

BMW 730i 8-cylinder, 740i/L

Coolant pump, alternator and power steering

7 K × 1605 ribbed V-belt

Air conditioning compressor

7 K × 980 ribbed V-belt

BMW 750i/L

Alternator and power steering

6 K × 1080 ribbed V-belt

Coolant pump and air conditioning

5 K × 1165 ribbed V-belt

2nd alternator

3 K × 590 ribbed V-belt

Tyre pressure – check regularly for your own safety

Incorrect tyre pressure can impair the car's stability or lead to tyre damage which could in turn result in an accident.

Tyre pressures in bar (gauge pressure) when cold (ambient temperature); values in brackets = lb/in² (psi).

Note: as the tyres become hot (e. g. fast main-road driving), pressure rises by approx. 0.3 bar (app. 4.0 lb/in²). For every change in temperature of 10° C, tyre pressure varies by 0.1 bar (1.4 lb/in²).



BMW model	Radial-ply tyres (tubeless)	max		Standard load	
730i 6-cylinder	205/65 R 15 94 V 225/60 R 15 95 V TD 230/55 ZR 390 240/45 ZR 415	2.2 (31)	2.7 (38)	2.6 (37)	3.1 (44)
	205/65 R 15 94 Q/T/H M+S 225/60 R 15 95 Q/T/H M+S TD 230/55 R 390 95 H M+S 240/45 R 415 94 H M+S	2.4 (34)	2.9 (41)	2.8 (40)	3.3 (47)
730i 8-cylinder	225/60 ZR 15 TD 230/55 ZR 390 240/45 ZR 415 205/65 R 15 94 Q/T M+S 225/60 R 15 95 Q/T/H M+S TD 230/55 R 390 95 H M+S 240/45 R 415 94 H M+S	2.3 (33)	2.7 (38)	2.6 (37)	3.1 (44)

Spark plugs**BMW 730i 6-cylinder**

Bosch W 8 LCR

Heat value
145**BMW 750i/iL**

Bosch F 8 LCR

145

Electrode gap



0.7 + 0.1 mm
(0.028 +
0.004 in)**BMW 730i 8-cylinder, 740i/iL**

Bosch F7 LDCR

NGK BKR 6 EK

(double-earth electrode)

Type pressure (continued)

BMW model	Radial-ply tyres (tubeless)				
740i/iL	225/60 ZR 15	2.3 (33)	2.8 (40)	2.8 (40)	3.3 (47)
	TD 230/55 ZR 390				
	240/45 ZR 415				
	225/60 R 15 95 Q/T/H M+S				
	TD 230/55 R 390 95 H M+S				
240/45 R 415 94 H M+S					
750i/iL	225/60 ZR 15	2.6 (37)	3.0 (43)	2.9 (41)	3.3 (47)
	TD 230/55 ZR 390				
	240/45 ZR 415				
	225/60 R 15 95 Q/T/H M+S				
	TD 230/55 R 390 95 H M+S				
240/45 R 415 94 H M+S					

When changing wheels or in the event of tyre failure:

If your BMW's wheels are secured with thiefproof (lockable) wheel studs, always carry the necessary adapter or key in the car's toolkit. This makes it easier for the workshop or breakdown service to perform the necessary work with no loss of time. See also page 92.

Tyre pressure can be reduced by max. 0.3 bar (app. 4 lb/in²) [BMW 750i/iL: 0.5 bar (app. 7 lb/in²)] on summer tyres in order to improve ride comfort if a speed of 200 km/h (app. 120 mile/h) is not exceeded.

However, only the higher pressure stated applies if a trailer is being towed.

The quoted pressures apply to makes of tyre recommended by BMW and known to BMW service stations. If other makes of tyre are fitted to the car, higher tyre pressures could be necessary.

A label which will also show tyre pressures for special model versions is attached to the driver's door post.



3.3
(47)

3.3
(47)

5 bar
km/h

tations.

or post.

Best. Nr. 01 41 9 787 701 englisch